



289-300

**MOBİLYA**

# ALUSYSTEMS

Aluminyum Kapı Pencere ve Giydirme Cephe Sistemleri  
Aluminium Window Doors and Facade Systems



# MİMARİ KATALOG

## ARCHITECTURAL CATALOGUE

Aluminyum Kapı Pencere ve Giydirme Cephe Sistemleri  
Aluminium Window Doors and Facade Systems



ALUSYSTEMS  
Profil Detayları  
ALUSYSTEMS  
Profile Details

# MOBİLYA

PROFİLLERİ  
PROFILES



# ALUSYSTEMS

Aluminyum Kapı Pencere ve Giydirme Cephe Sistemleri  
Aluminium Window Doors and Facade Systems



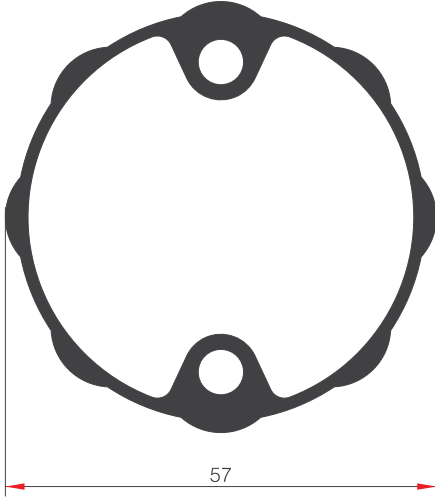

59673

AĞIRLIK (kg/m) / WEIGHT  
1309.2

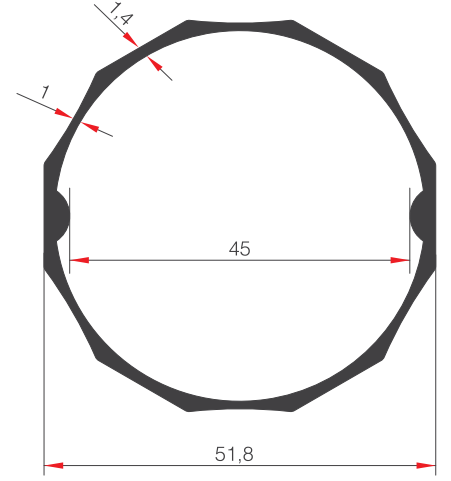

45254

AĞIRLIK (kg/m) / WEIGHT  
724,60

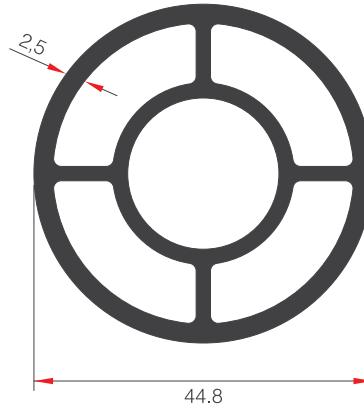

39480

AĞIRLIK (kg/m) / WEIGHT  
1446.6

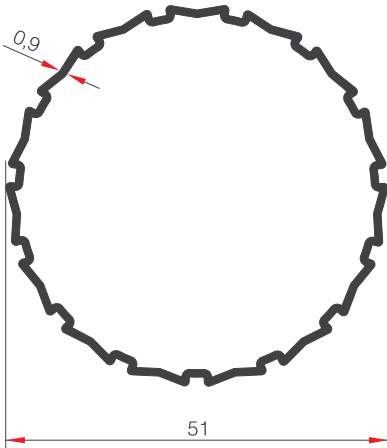

36744

AĞIRLIK (kg/m) / WEIGHT  
442,8

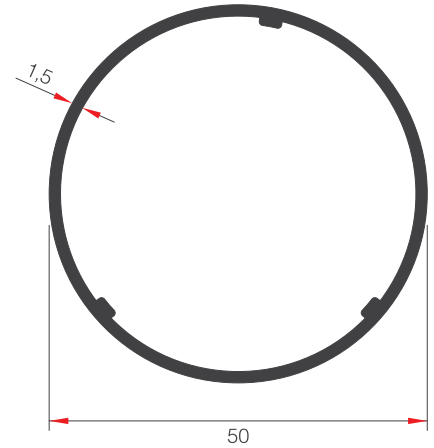

39814

AĞIRLIK (kg/m) / WEIGHT  
642.8

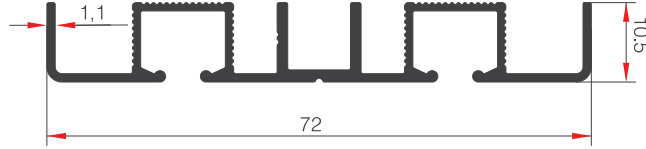

17819

AĞIRLIK (kg/m) / WEIGHT  
489

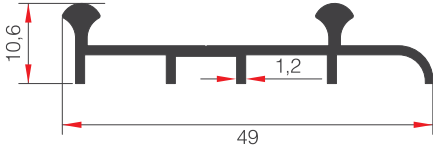

39910

AĞIRLIK (kg/m) / WEIGHT  
296,40

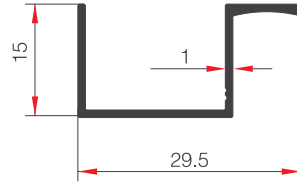

17820

AĞIRLIK (kg/m) / WEIGHT  
159

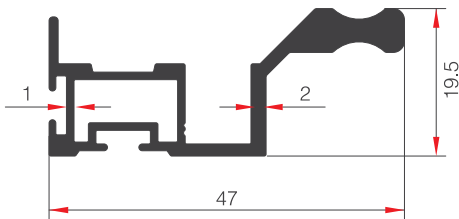

17817

AĞIRLIK (kg/m) / WEIGHT  
546

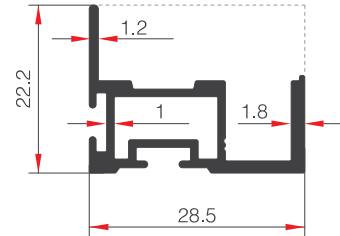

17818

AĞIRLIK (kg/m) / WEIGHT  
349

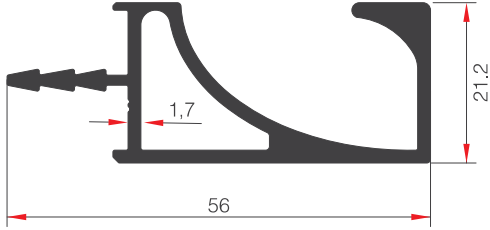

17751

AĞIRLIK (kg/m) / WEIGHT  
724

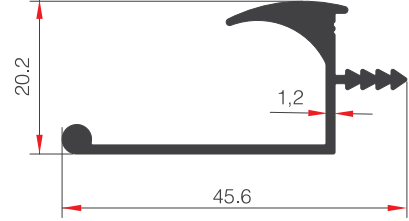

17748

AĞIRLIK (kg/m) / WEIGHT  
359

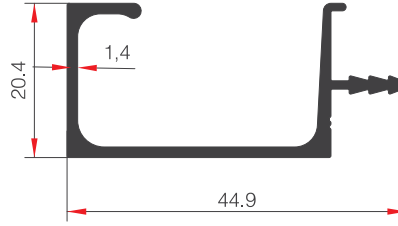

17814

AĞIRLIK (kg/m) / WEIGHT  
376

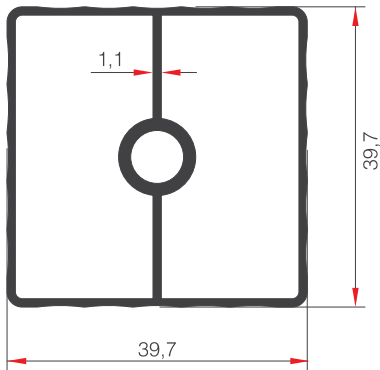

43559

AĞIRLIK (kg/m) / WEIGHT  
607,80

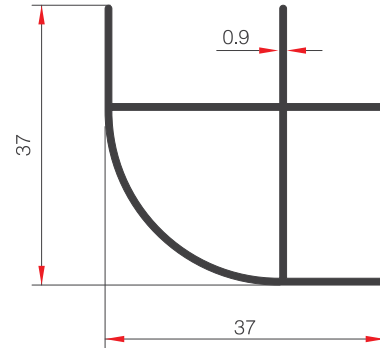

59634

AĞIRLIK (kg/m) / WEIGHT  
327.6

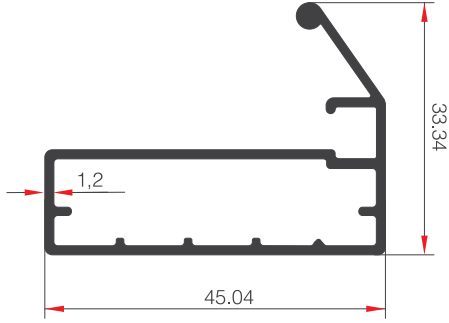

18308

AĞIRLIK (kg/m) / WEIGHT  
507

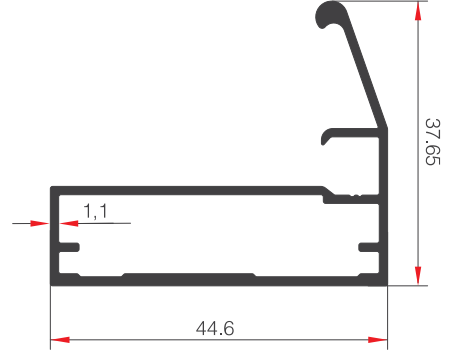

17822

AĞIRLIK (kg/m) / WEIGHT  
505

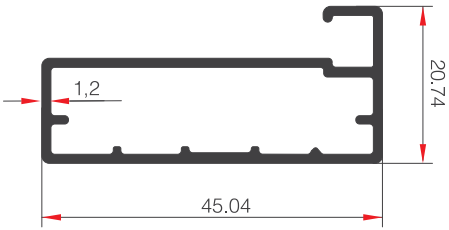

18307

AĞIRLIK (kg/m) / WEIGHT  
447

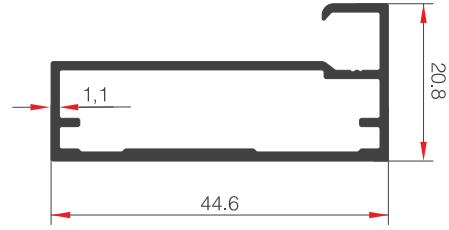

17821

AĞIRLIK (kg/m) / WEIGHT  
430

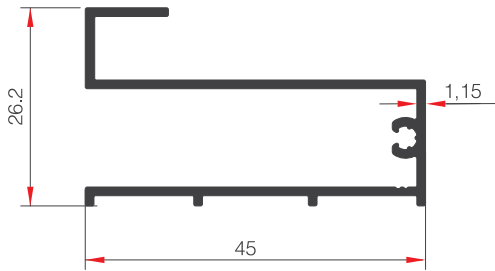

17897

AĞIRLIK (kg/m) / WEIGHT  
424

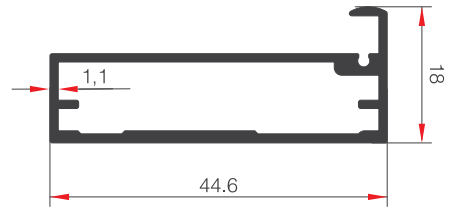

18145

AĞIRLIK (kg/m) / WEIGHT  
424



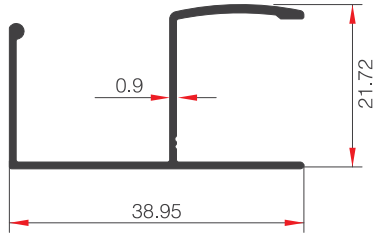

17812

AĞIRLIK (kg/m) / WEIGHT  
243

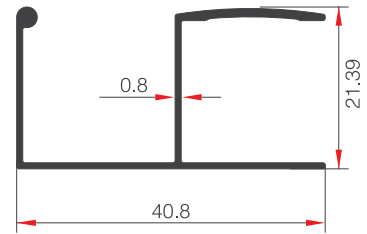

17743

AĞIRLIK (kg/m) / WEIGHT  
242

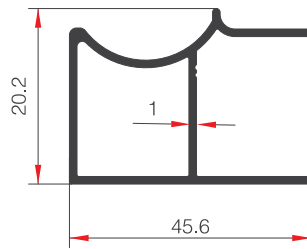

17747

AĞIRLIK (kg/m) / WEIGHT  
281

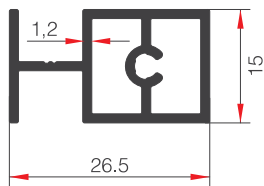

17816

AĞIRLIK (kg/m) / WEIGHT  
323

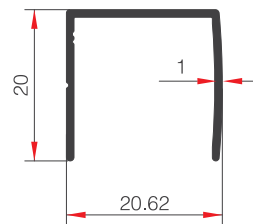

17813

AĞIRLIK (kg/m) / WEIGHT  
155

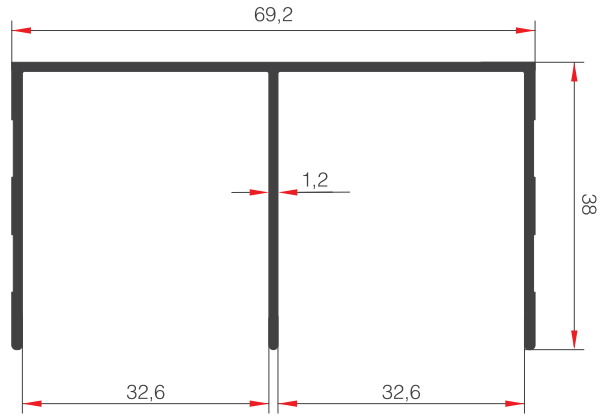

39909

AĞIRLIK (kg/m) / WEIGHT  
563

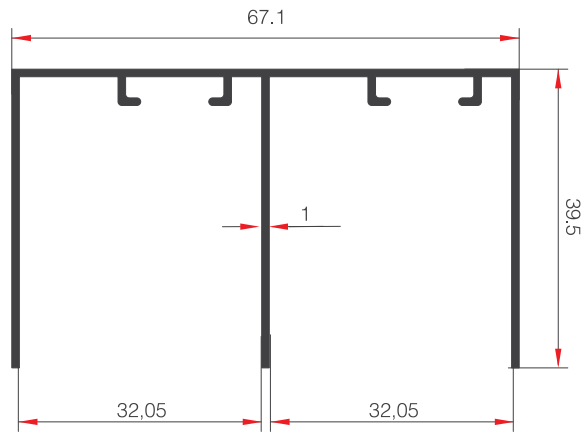

15046

AĞIRLIK (kg/m) / WEIGHT  
557

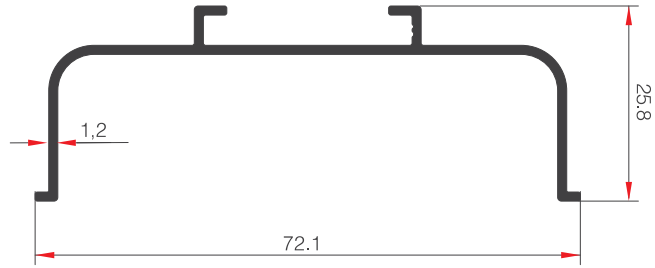

17745

AĞIRLIK (kg/m) / WEIGHT  
397

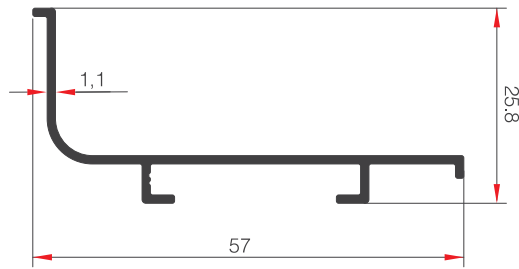

17744

AĞIRLIK (kg/m) / WEIGHT  
275

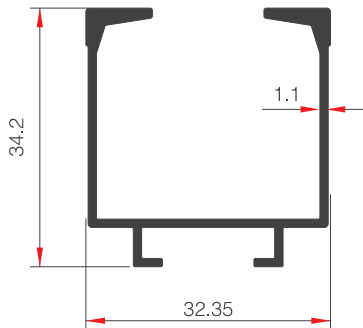

14897

AĞIRLIK (kg/m) / WEIGHT  
402

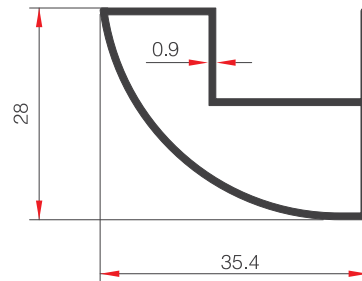

15049

AĞIRLIK (kg/m) / WEIGHT  
297

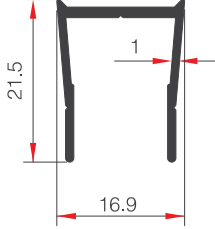

17793

AĞIRLIK (kg/m) / WEIGHT  
178

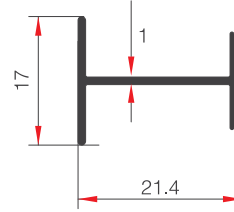

17742

AĞIRLIK (kg/m) / WEIGHT  
132

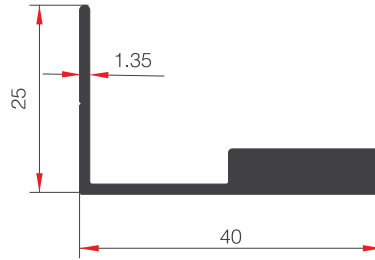

17750

AĞIRLIK (kg/m) / WEIGHT  
486

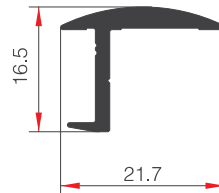

17746

AĞIRLIK (kg/m) / WEIGHT  
199