



109-158

SWT 55

ALUSYSTEMS

Aluminyum Kapı Pencere ve Giydirme Cephe Sistemleri
Aluminium Window Doors and Facade Systems



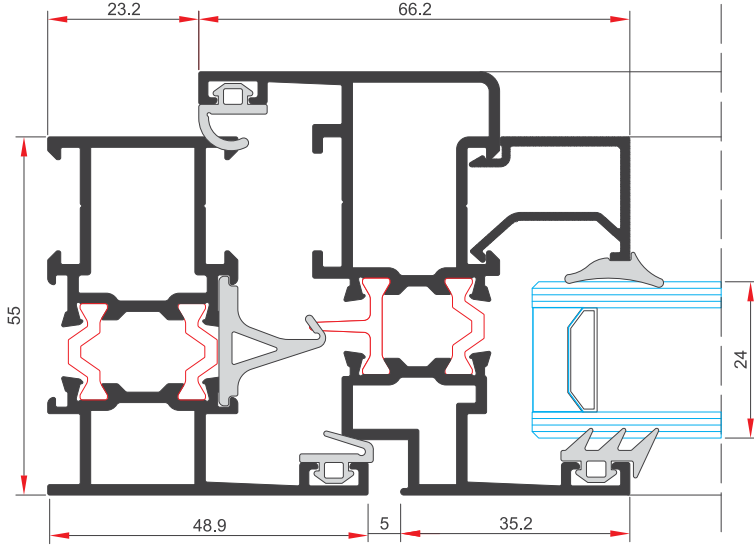

TEKNİK DETAYLAR | TECHNICAL DETAILS



KASA GENİRLİĞİ : 55 MM
FRAME WIDTH : 55 MM



ISI BARIYERİ : 14.8 MM
HEAT BARRIER : 14.8 MM



ET KALINLIĞI : 1.3 MM - 1.5 MM - 1.6 MM - 1.8 MM - 2 MM
WALL THICKNESS : 1.2 MM - 1.5 MM - 1.6 MM - 1.8 MM - 2 MM



CAM KALINLIĞI : 4 MM ~ 32 MM
GLASS THICKNESS : 4 MM ~ 32 MM



AKSESUAR KANAL TİPİ : EUROGROOVE 1 KANALA UYGUN - PVC KANAL (9 AKS) UYGUN KANATLAR
ACCESSORY CHANNEL TYPE : EUROGROOVE SUITABLE FOR 1 CHANNEL - PVC (9 AXLES) SUITABLE WINGS



AÇILIM ÇEŞİTLERİ : TEK AÇILIM PENCERE, ÇİFT AÇILIM PENCERE, VASİSTAS AÇILIM, İÇE AÇILIR TEK KANAT KAPI, İÇE AÇILIR ÇİFT KANAT KAPI, KATLANIR KAPI, PARALEL SÜRME, DIŞA AÇILIM KAPI
EXPANSION TYPES : SINGLE OPENING WINDOW, DOUBLE OPENING WINDOW, TRANSOM OPENING, INWARD OPENING SINGLE WING DOOR, INWARD OPENING DOUBLE WING DOOR, FOLDING DOOR, PARALLEL SLIDING, OUTWARD OPENING DOOR



ISI GEÇİRGENLİK KAT SAYISI (Uf) : 3.53 W/m².K
HEAT CONDUCTIVITY COEFFICIENT (Uf) : 3.53 W/m².K

ALUSYSTEMS

Aluminyum Kapı Pencere ve Giydirme Cephe Sistemleri
Aluminium Window Doors and Facade Systems



MİMARİ KATALOG

ARCHITECTURAL CATALOGUE

Aluminyum Kapı Pencere ve Giydirme Cephe Sistemleri
Aluminium Window Doors and Facade Systems



ALUSYSTEMS
Profil Detayları
ALUSYSTEMS
Profile Details

SWT55

PROFİLLER
PROFILES



ALUSYSTEMS

Aluminyum Kapı Pencere ve Giydirme Cephe Sistemleri
Aluminium Window Doors and Facade Systems



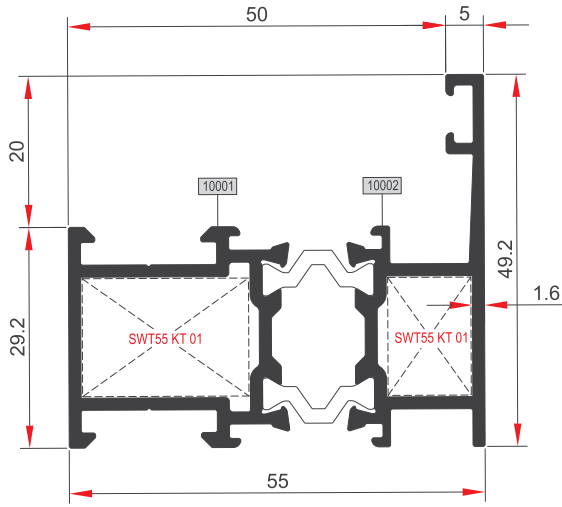

SWT55 KS 01

AĞIRLIK (kg/m) / WEIGHT kg/m	1.217
Jx (cm ⁴)	14.270
Jy (cm ⁴)	5.639

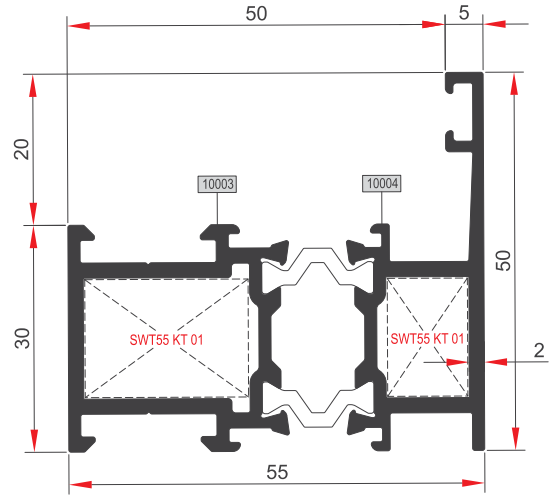

SWT55 KS 02

AĞIRLIK (kg/m) / WEIGHT kg/m	1.343
Jx (cm ⁴)	16.255
Jy (cm ⁴)	6.227

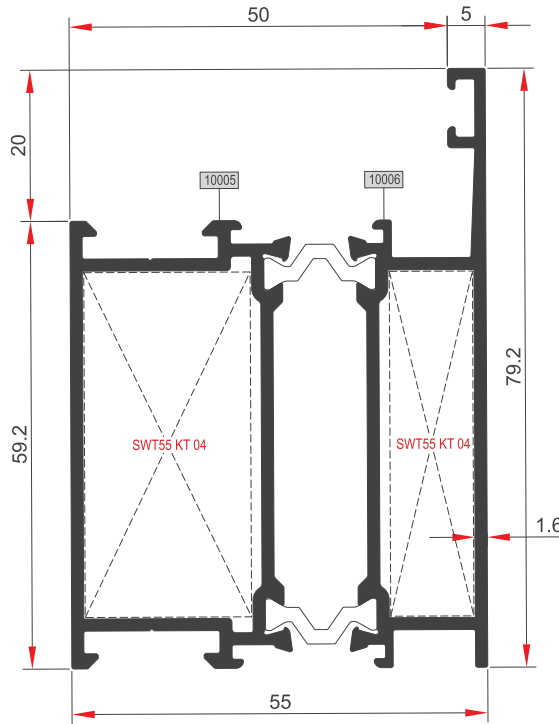

SWT55 KS 03

AĞIRLIK (kg/m) / WEIGHT kg/m	1.736
Jx (cm ⁴)	21.737
Jy (cm ⁴)	28.504

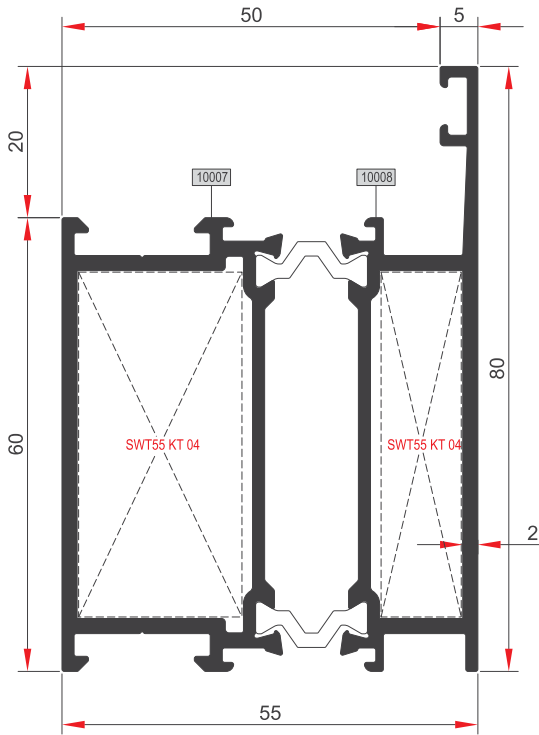

SWT55 KS 04

AĞIRLIK (kg/m) / WEIGHT kg/m	1.926
Jx (cm ⁴)	25.321
Jy (cm ⁴)	31.709

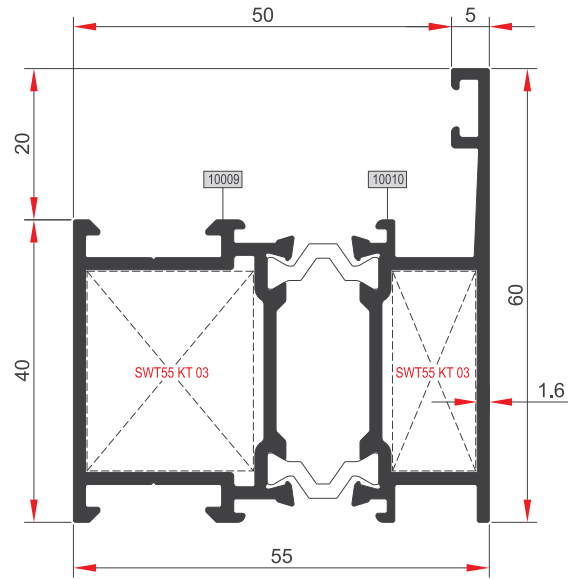

SWT55 KS 05

AĞIRLIK (kg/m) / WEIGHT kg/m	1.404
Jx (cm ⁴)	16.959
Jy (cm ⁴)	11.292

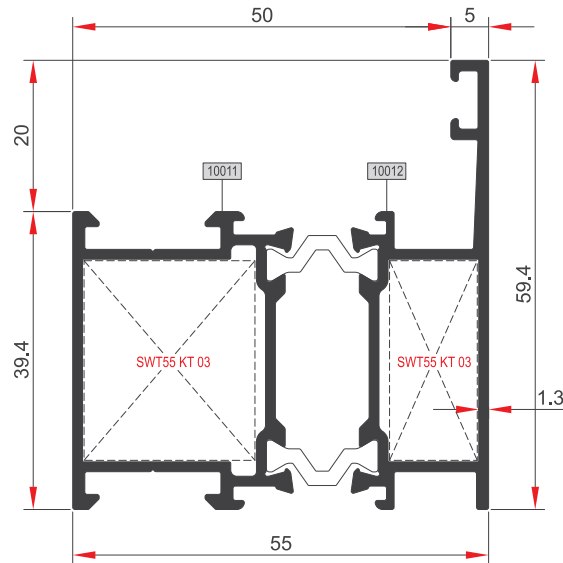

SWT55 KS 06

AĞIRLIK (kg/m) / WEIGHT kg/m	1.246
Jx (cm ⁴)	14.877
Jy (cm ⁴)	10.258

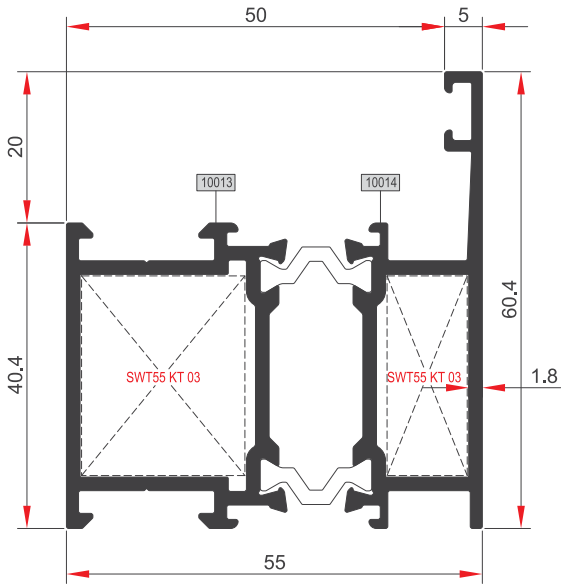

SWT55 KS 07

AĞIRLIK (kg/m) / WEIGHT kg/m	1.510
Jx (cm ⁴)	18.333
Jy (cm ⁴)	11.995

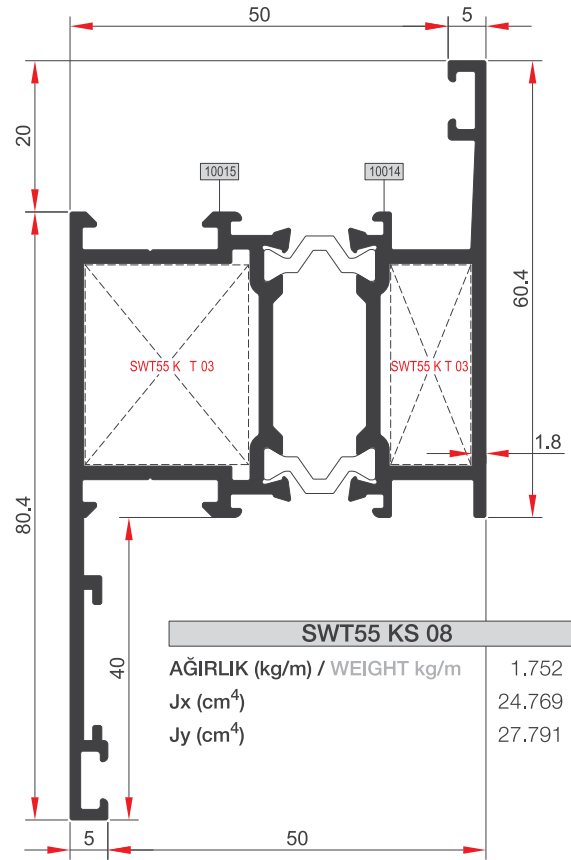

SWT55 KS 08

AĞIRLIK (kg/m) / WEIGHT kg/m	1.752
Jx (cm ⁴)	24.769
Jy (cm ⁴)	27.791

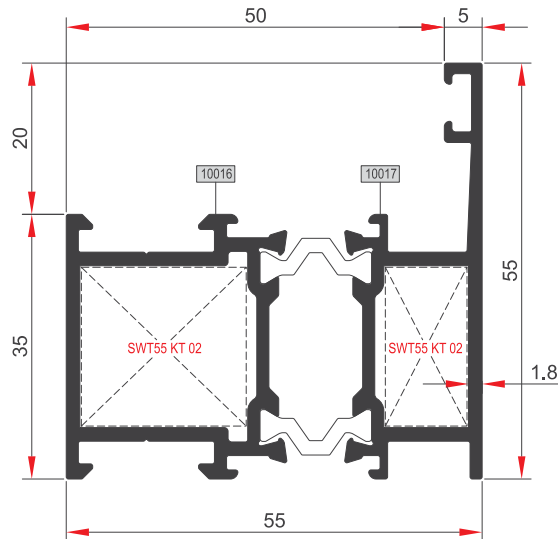

SWT55 KS 09

AĞIRLIK (kg/m) / WEIGHT kg/m	1.379
Jx (cm ⁴)	16.758
Jy (cm ⁴)	8.574

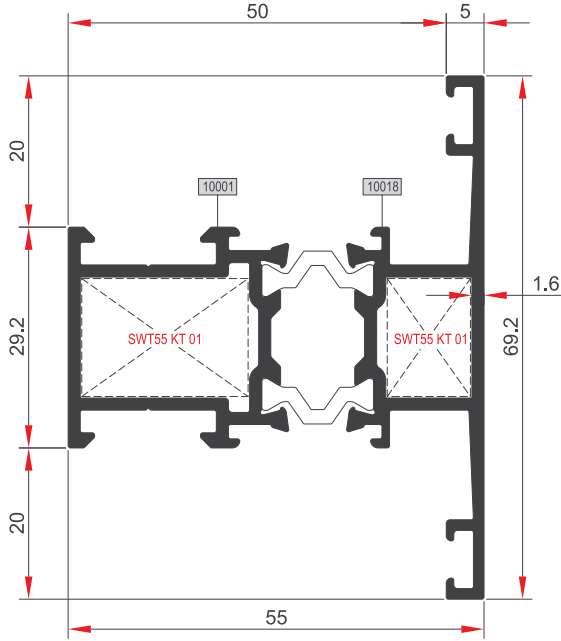

SWT55 KY 01

AĞIRLIK (kg/m) / WEIGHT kg/m	1.336
Jx (cm ⁴)	16.329
Jy (cm ⁴)	8.928

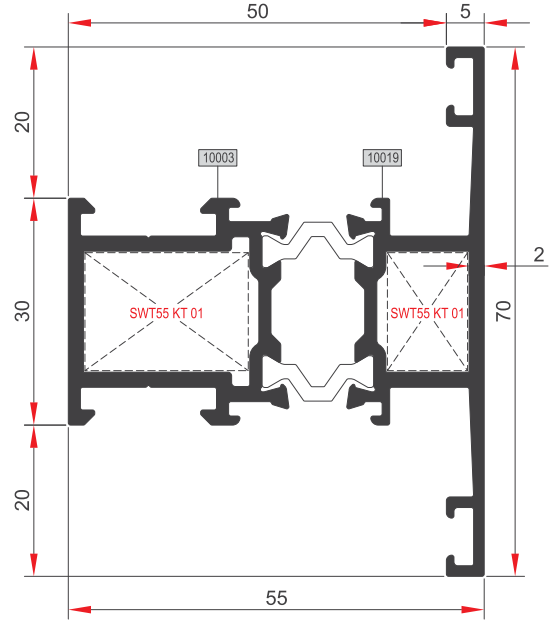

SWT55 KY 02

AĞIRLIK (kg/m) / WEIGHT kg/m	1.462
Jx (cm ⁴)	18.425
Jy (cm ⁴)	9.584

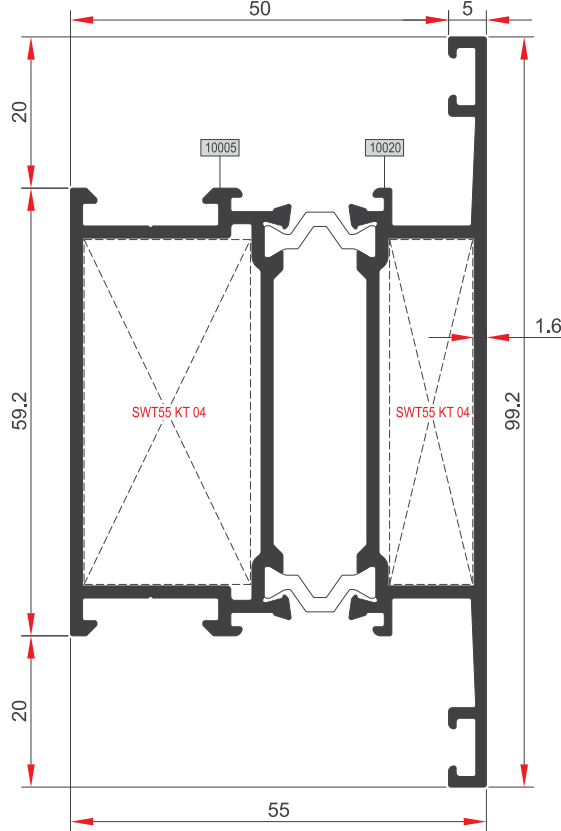

SWT55 KY 03

AĞIRLIK (kg/m) / WEIGHT kg/m	1.855
Jx (cm ⁴)	23.891
Jy (cm ⁴)	36.344

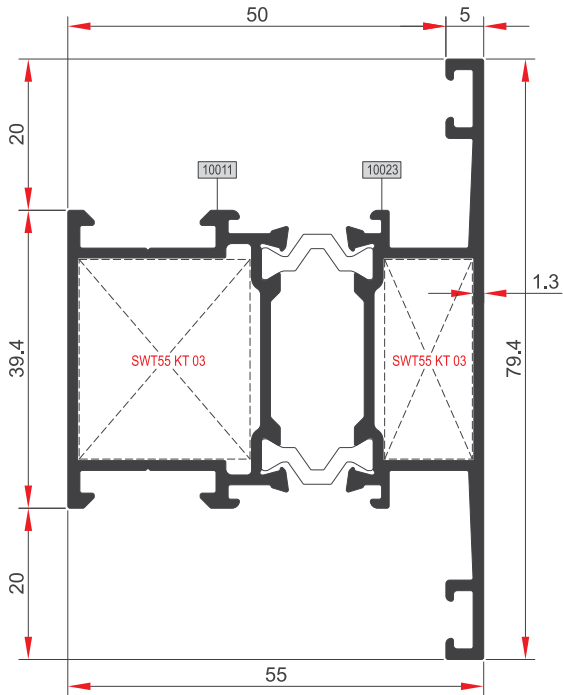

SWT55 KY 06

AĞIRLIK (kg/m) / WEIGHT kg/m	1.365
Jx (cm ⁴)	16.888
Jy (cm ⁴)	14.921

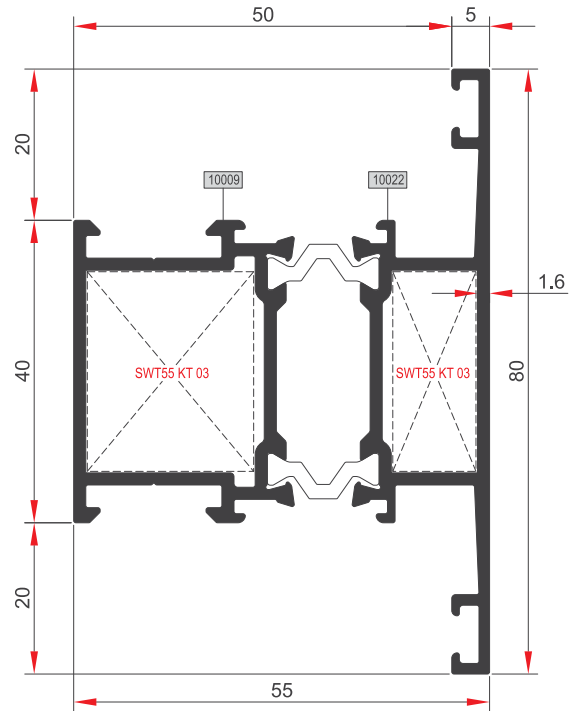

SWT55 KY 05

AĞIRLIK (kg/m) / WEIGHT kg/m	1.523
Jx (cm ⁴)	19.059
Jy (cm ⁴)	14.990

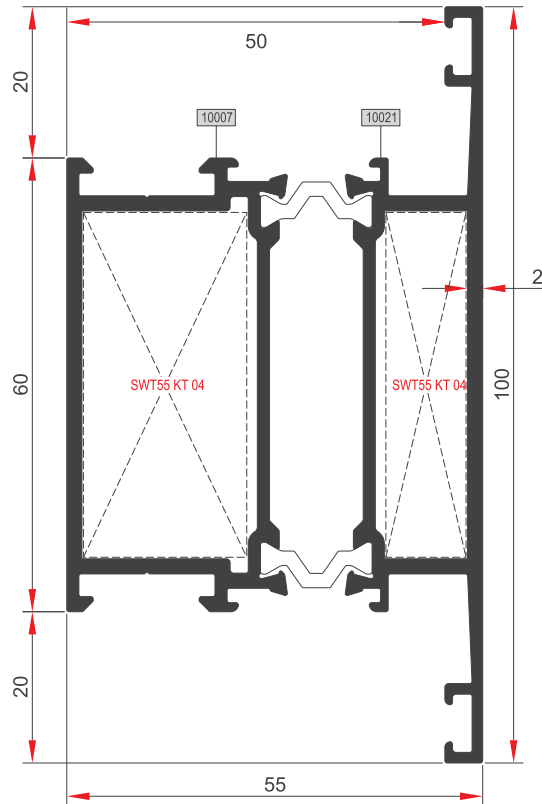

SWT55 KY 04

AĞIRLIK (kg/m) / WEIGHT kg/m	2.045
Jx (cm ⁴)	27.573
Jy (cm ⁴)	39.647

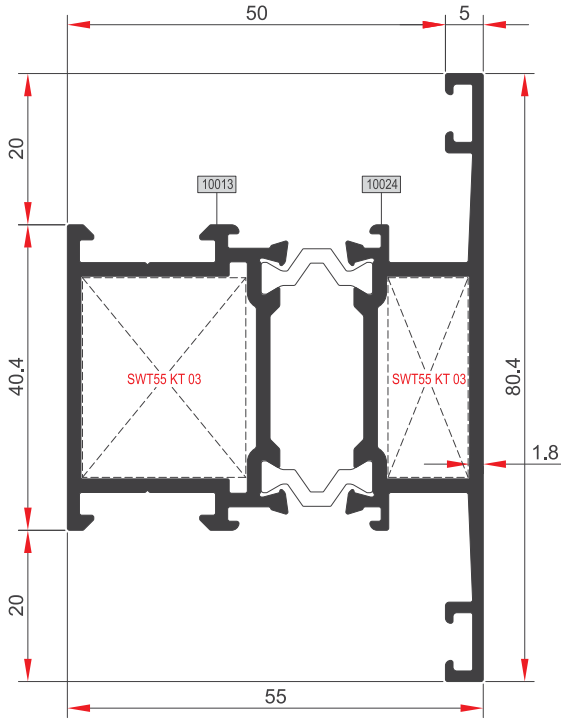

SWT55 KY 07

AĞIRLIK (kg/m) / WEIGHT kg/m	1.629
Jx (cm ⁴)	20.484
Jy (cm ⁴)	16.723

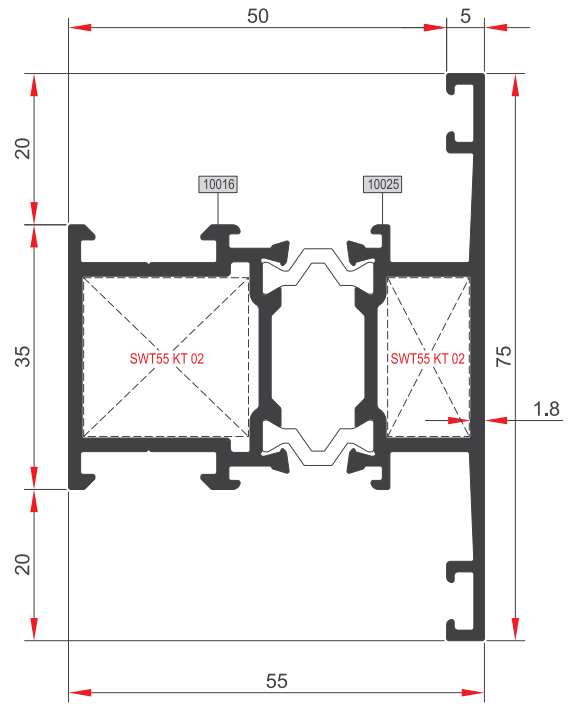

SWT55 KY 08

AĞIRLIK (kg/m) / WEIGHT kg/m	1.498
Jx (cm ⁴)	18.896
Jy (cm ⁴)	12.571

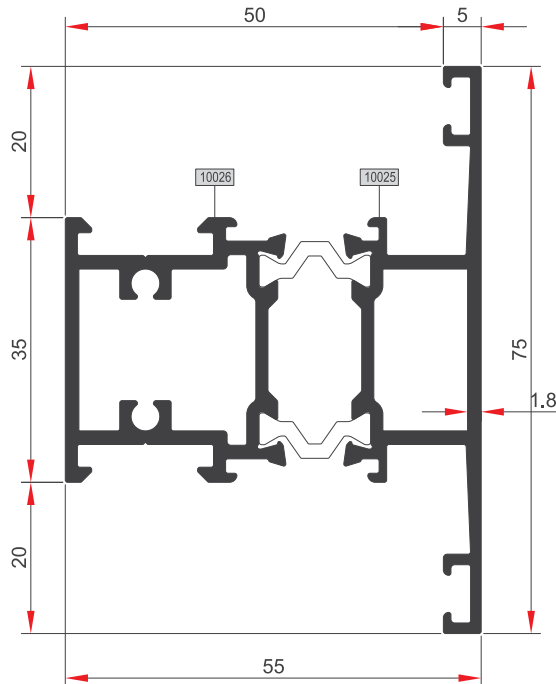

SWT55 KY 09

AĞIRLIK (kg/m) / WEIGHT kg/m	1.580
Jx (cm ⁴)	20.278
Jy (cm ⁴)	12.806

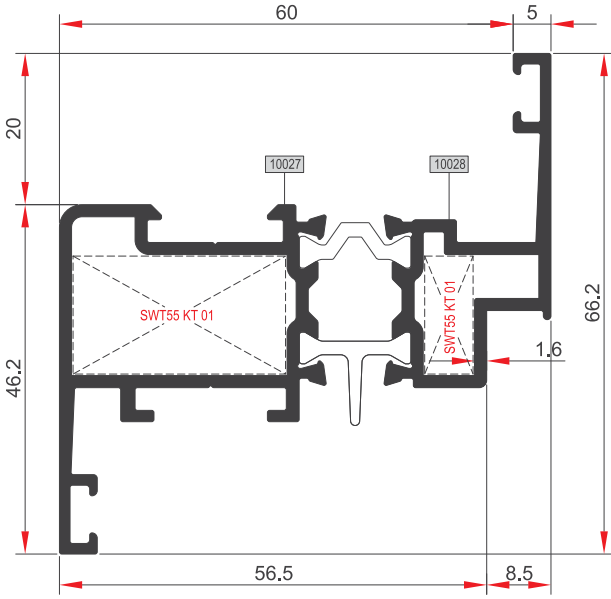

SWT55 KN 01

AĞIRLIK (kg/m) / WEIGHT kg/m	1.398
Jx (cm ⁴)	24.046
Jy (cm ⁴)	8.215

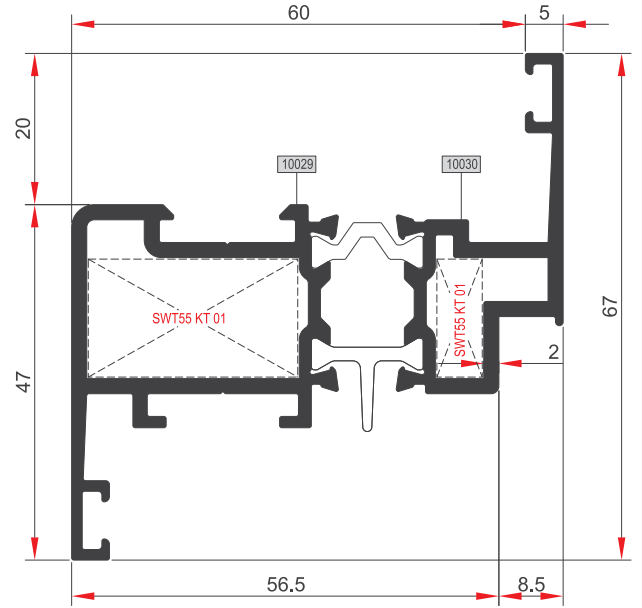

SWT55 KN 02

AĞIRLIK (kg/m) / WEIGHT kg/m	1.553
Jx (cm ⁴)	27.094
Jy (cm ⁴)	8.944

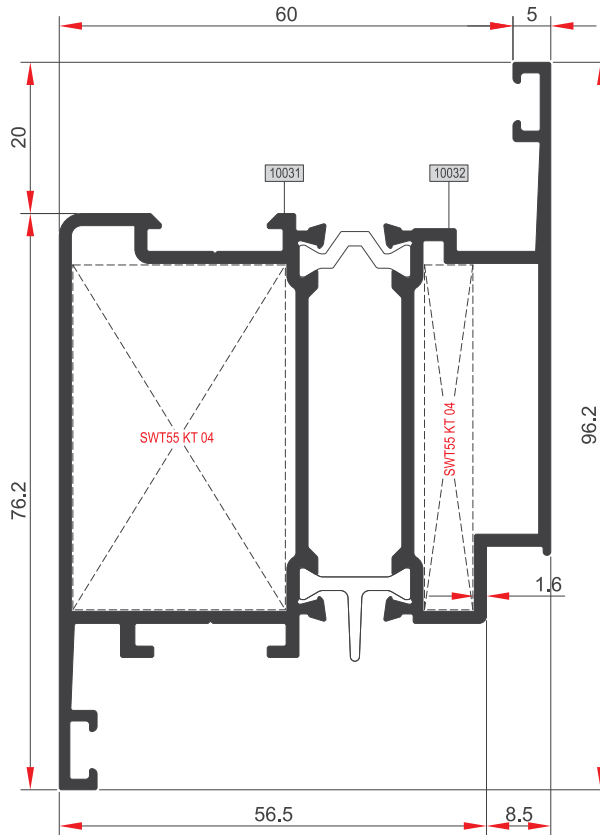

SWT55 KN 03

AĞIRLIK (kg/m) / WEIGHT kg/m	1.916
Jx (cm ⁴)	34.571
Jy (cm ⁴)	35.569

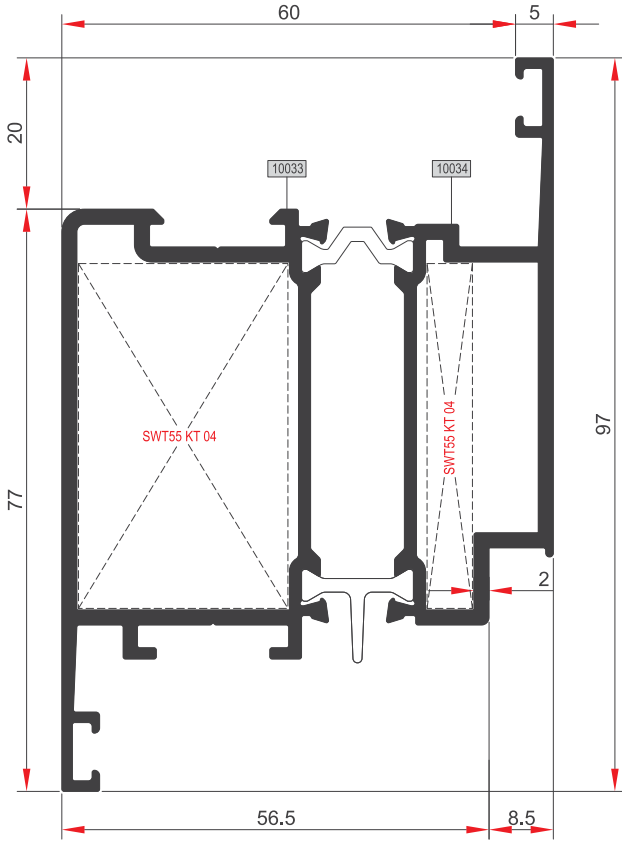

SWT55 KN 04

AĞIRLIK (kg/m) / WEIGHT kg/m	2.137
Jx (cm ⁴)	39.920
Jy (cm ⁴)	39.446

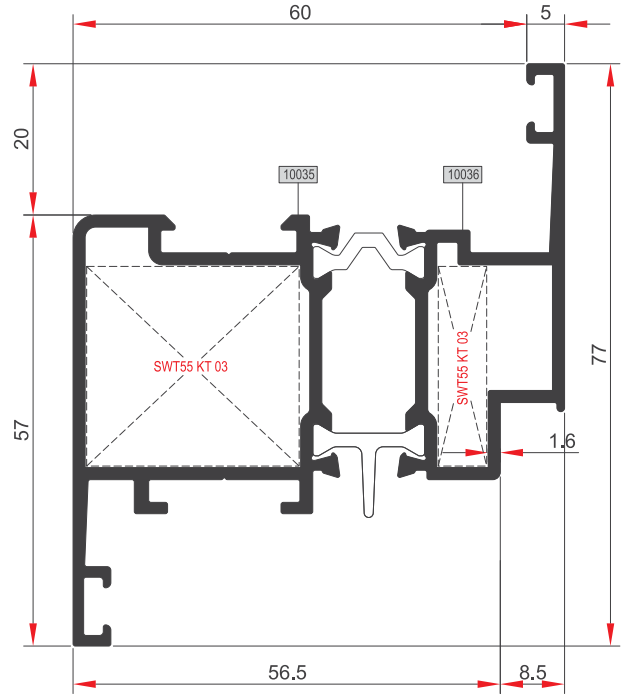

SWT55 KN 05

AĞIRLIK (kg/m) / WEIGHT kg/m	1.585
Jx (cm ⁴)	27.851
Jy (cm ⁴)	15.158

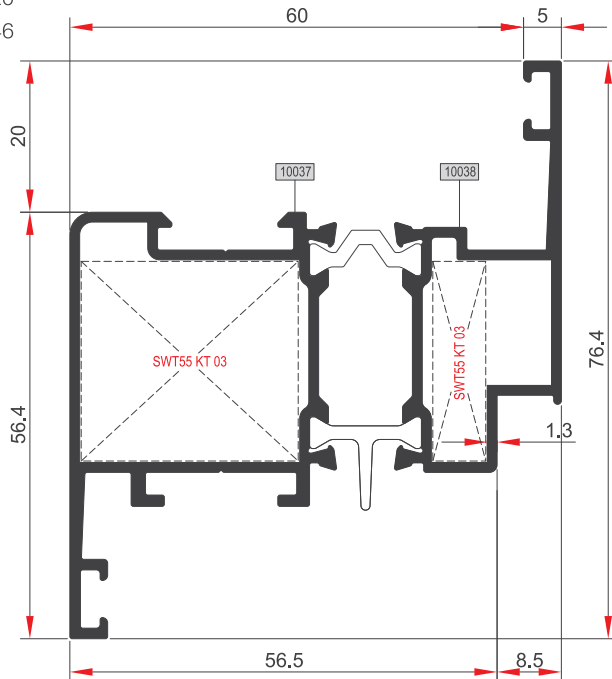

SWT55 KN 06

AĞIRLIK (kg/m) / WEIGHT kg/m	1.404
Jx (cm ⁴)	24.707
Jy (cm ⁴)	13.944

SWT55

KANAT PROFİLLERİ
SASH PROFILES

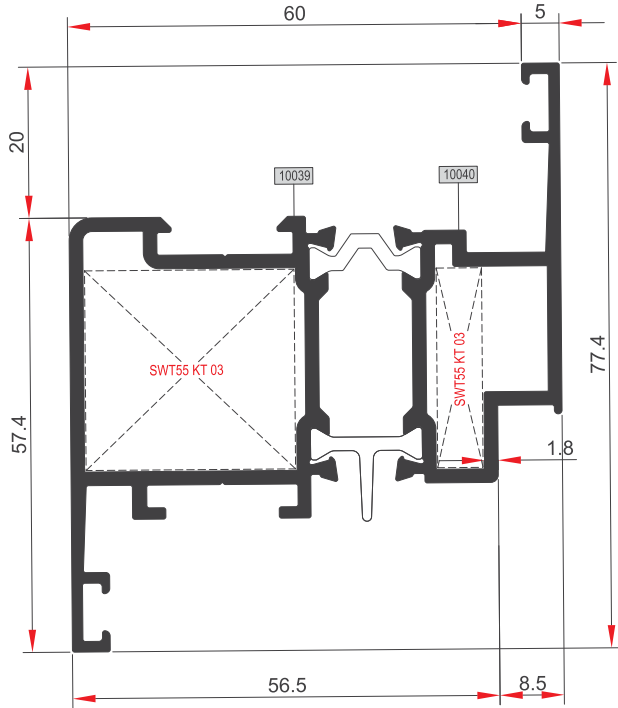

SWT55 KN 07

AĞIRLIK (kg/m) / WEIGHT kg/m	1.705
Jx (cm ⁴)	29.938
Jy (cm ⁴)	15.983

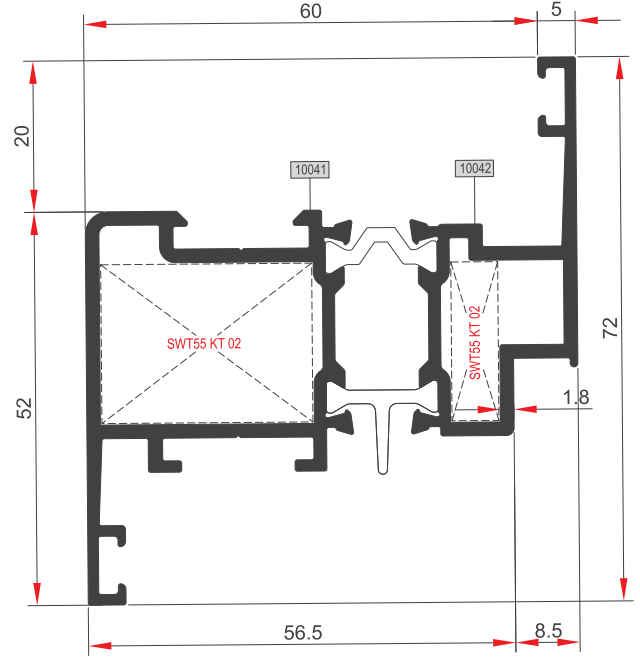

SWT55 KN 08

AĞIRLIK (kg/m) / WEIGHT kg/m	1.575
Jx (cm ⁴)	27.690
Jy (cm ⁴)	11.846

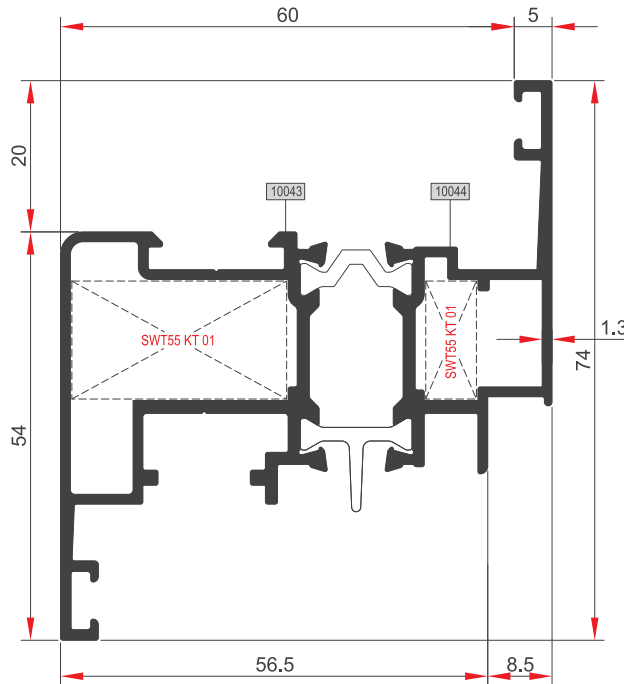

SWT55 KN 09

AĞIRLIK (kg/m) / WEIGHT kg/m	1.488
Jx (cm ⁴)	24.751
Jy (cm ⁴)	11.932

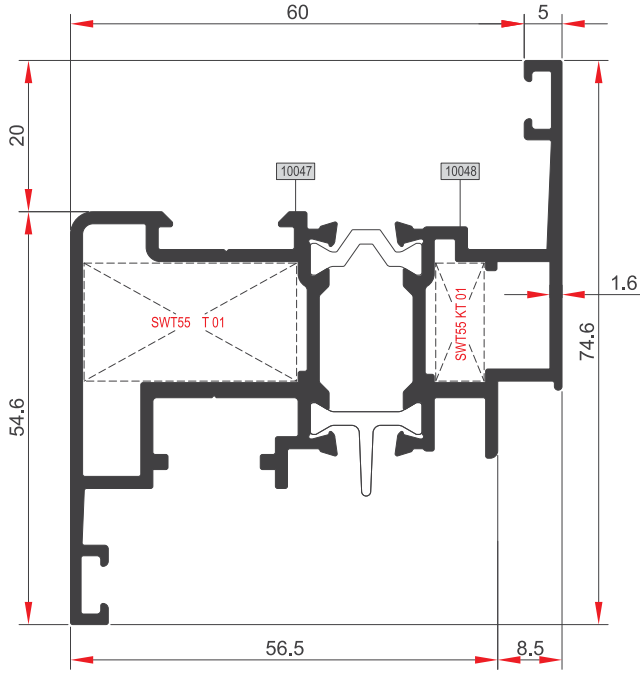

SWT55 KN 11

AĞIRLIK (kg/m) / WEIGHT kg/m	1.629
Jx (cm ⁴)	27.810
Jy (cm ⁴)	12.848

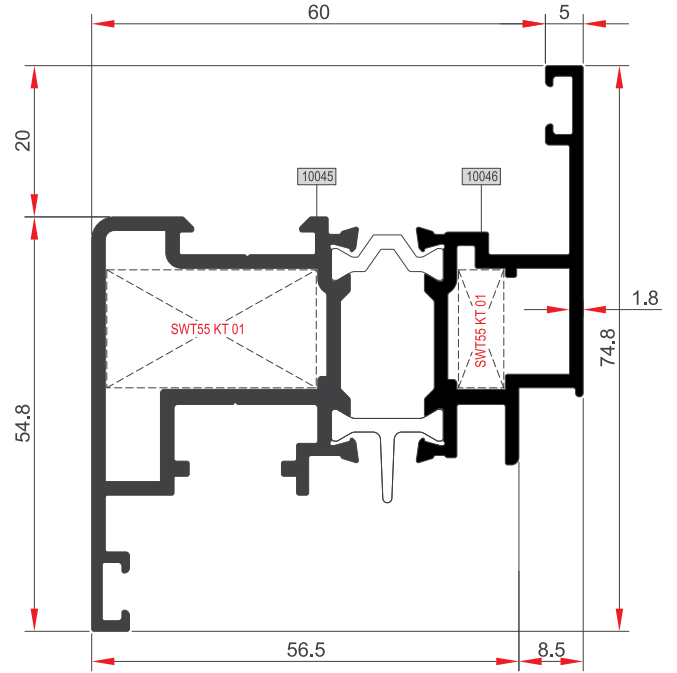

SWT55 KN 10

AĞIRLIK (kg/m) / WEIGHT kg/m	1.739
Jx (cm ⁴)	30.004
Jy (cm ⁴)	13.524

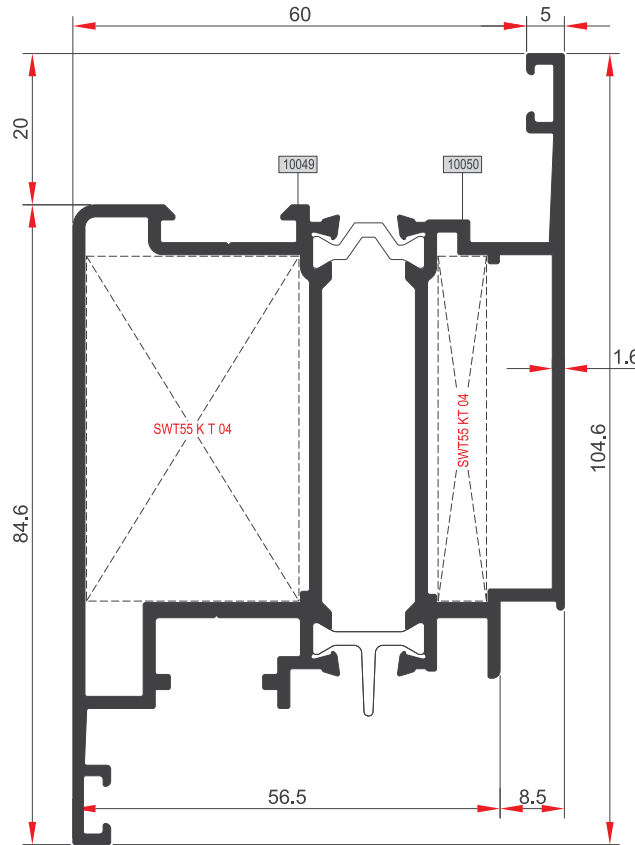

SWT55 KN 12

AĞIRLIK (kg/m) / WEIGHT kg/m	2.148
Jx (cm ⁴)	38.349
Jy (cm ⁴)	48.130

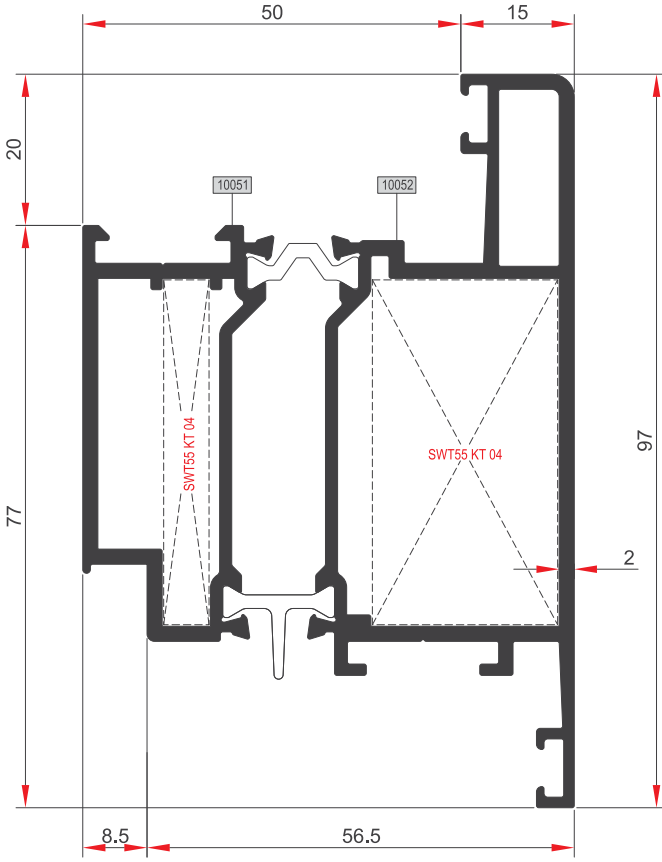

SWT55 KN 13

AĞIRLIK (kg/m) / WEIGHT kg/m	2.311
Jx (cm ⁴)	41.175
Jy (cm ⁴)	48.221

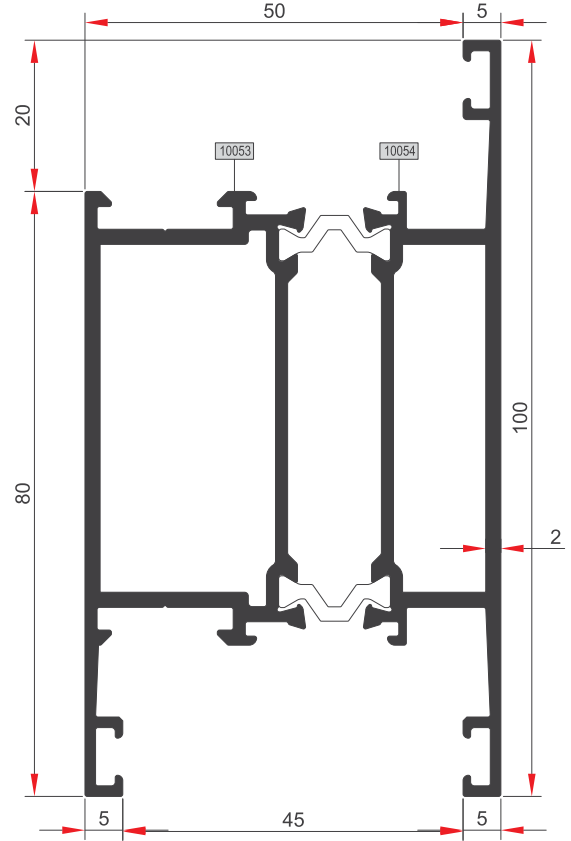

SWT55 KE 01

AĞIRLIK (kg/m) / WEIGHT kg/m	2.160
Jx (cm ⁴)	31.199
Jy (cm ⁴)	46.573

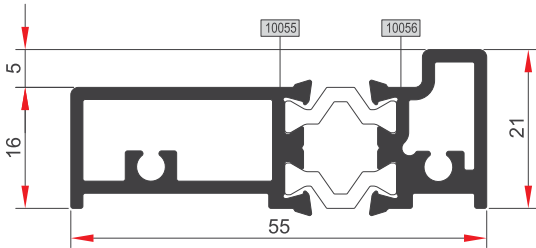

SWT55 KE 02

AĞIRLIK (kg/m) / WEIGHT kg/m	0.946
Jx (cm ⁴)	9.877
Jy (cm ⁴)	1.082

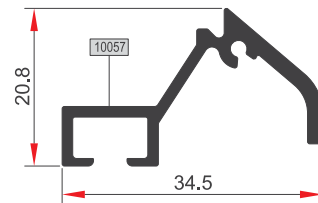

SWT55 KE 03

AĞIRLIK (kg/m) / WEIGHT kg/m	0.315
Jx (cm ⁴)	1.306
Jy (cm ⁴)	0.346

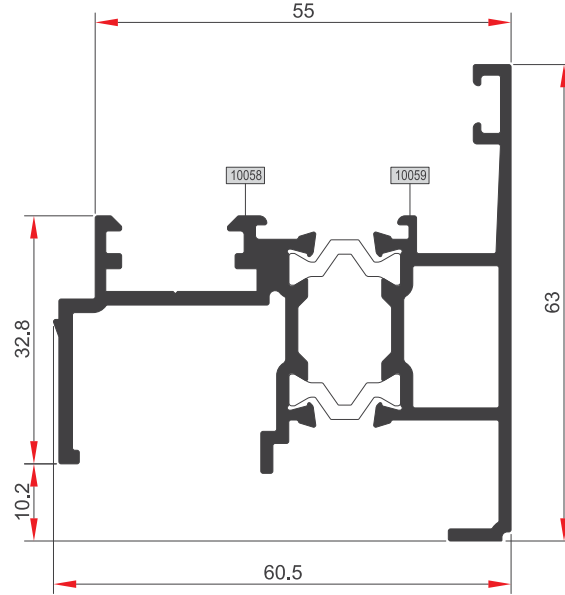

SWT55 AD 01

AĞIRLIK (kg/m) / WEIGHT kg/m	1.331
Jx (cm ⁴)	17.880
Jy (cm ⁴)	7.773

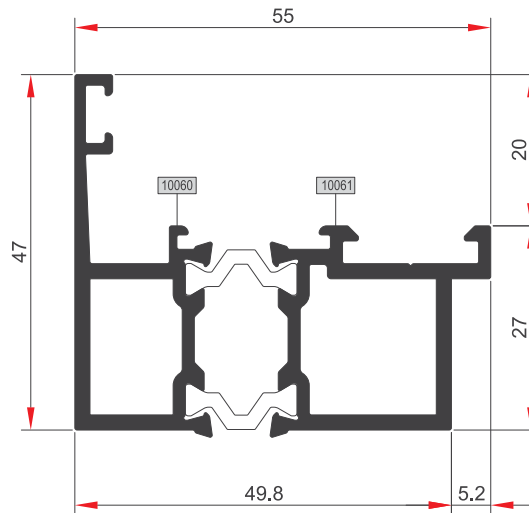

SWT55 AD 01

AĞIRLIK (kg/m) / WEIGHT kg/m	1.235
Jx (cm ⁴)	13.345
Jy (cm ⁴)	5.543

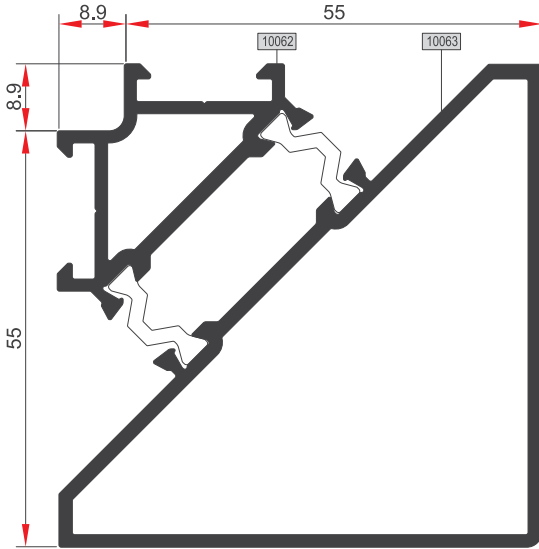

SWT55 AD 03

AĞIRLIK (kg/m) / WEIGHT kg/m	1.756
Jx (cm ⁴)	27.274
Jy (cm ⁴)	27.274

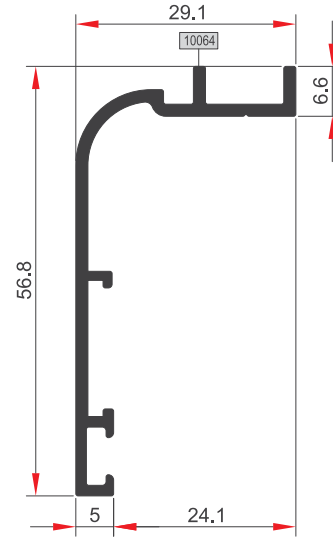

SWT55 AD 04

AĞIRLIK (kg/m) / WEIGHT kg/m	0.429
Jx (cm ⁴)	1.330
Jy (cm ⁴)	5.343

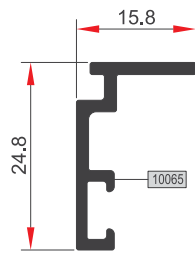

SWT55 AD 05

AĞIRLIK (kg/m) / WEIGHT kg/m	0.205
Jx (cm ⁴)	0.122
Jy (cm ⁴)	0.523

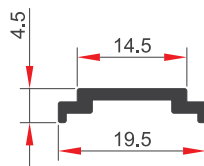

SWT55 T 01

AĞIRLIK (kg/m) / WEIGHT kg/m	0.105
Jx (cm ⁴)	0.144
Jy (cm ⁴)	0.005

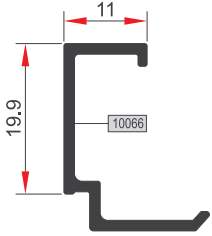

SWT55 C 01	
AĞIRLIK (kg/m) / WEIGHT kg/m	0,205
Jx (cm ⁴)	0,206
Jy (cm ⁴)	0,666

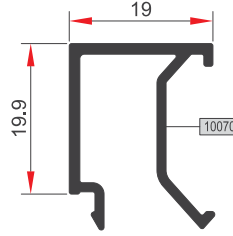

SWT55 C 05	
AĞIRLIK (kg/m) / WEIGHT kg/m	0,261
Jx (cm ⁴)	0,383
Jy (cm ⁴)	0,638

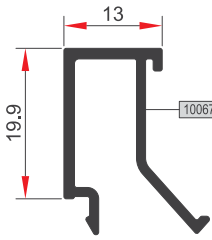

SWT55 C 02	
AĞIRLIK (kg/m) / WEIGHT kg/m	0,237
Jx (cm ⁴)	0,261
Jy (cm ⁴)	0,558

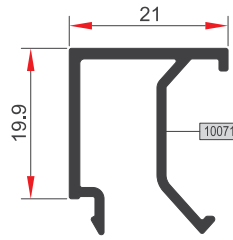

SWT55 C 06	
AĞIRLIK (kg/m) / WEIGHT kg/m	0,269
Jx (cm ⁴)	0,429
Jy (cm ⁴)	0,660

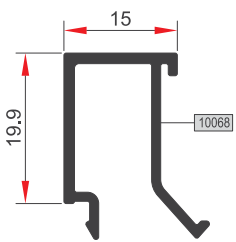

SWT55 C 03	
AĞIRLIK (kg/m) / WEIGHT kg/m	0,242
Jx (cm ⁴)	0,309
Jy (cm ⁴)	0,582

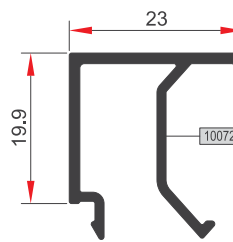

SWT55 C 07	
AĞIRLIK (kg/m) / WEIGHT kg/m	0,277
Jx (cm ⁴)	0,488
Jy (cm ⁴)	0,681

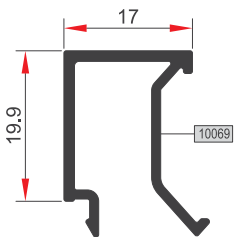

SWT55 C 04	
AĞIRLIK (kg/m) / WEIGHT kg/m	0,254
Jx (cm ⁴)	0,348
Jy (cm ⁴)	0,615

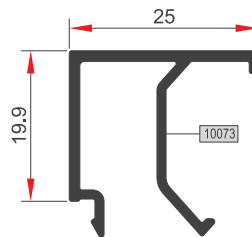

SWT55 C 08	
AĞIRLIK (kg/m) / WEIGHT kg/m	0,284
Jx (cm ⁴)	0,561
Jy (cm ⁴)	0,701

SWT55

CAM ÇITA PROFİLLERİ
GLAZING BEAD PROFILES

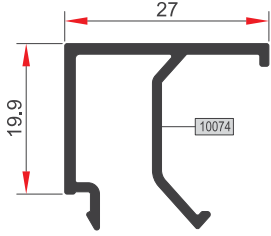

SWT55 C 09	
AĞIRLIK (kg/m) / WEIGHT kg/m	0,292
Jx (cm ⁴)	0,648
Jy (cm ⁴)	0,719

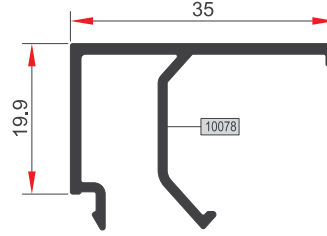

SWT55 C 13	
AĞIRLIK (kg/m) / WEIGHT kg/m	0,322
Jx (cm ⁴)	1,064
Jy (cm ⁴)	0,786

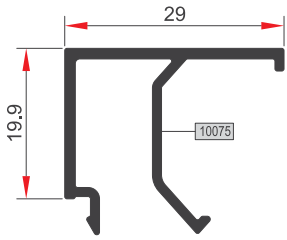

SWT55 C 10	
AĞIRLIK (kg/m) / WEIGHT kg/m	0,299
Jx (cm ⁴)	0,751
Jy (cm ⁴)	0,737

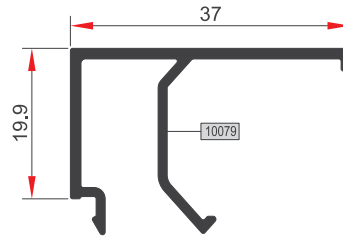

SWT55 C 14	
AĞIRLIK (kg/m) / WEIGHT kg/m	0,329
Jx (cm ⁴)	1,340
Jy (cm ⁴)	0,801

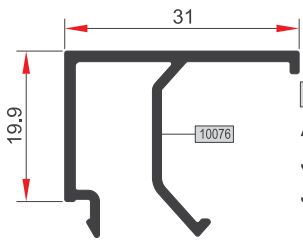

SWT55 C 11	
AĞIRLIK (kg/m) / WEIGHT kg/m	0,307
Jx (cm ⁴)	0,871
Jy (cm ⁴)	0,754

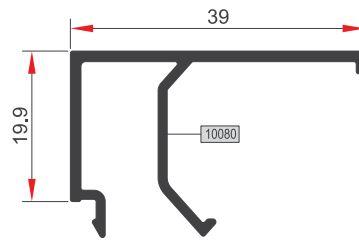

SWT55 C 14	
AĞIRLIK (kg/m) / WEIGHT kg/m	0,304
Jx (cm ⁴)	1,536
Jy (cm ⁴)	0,815

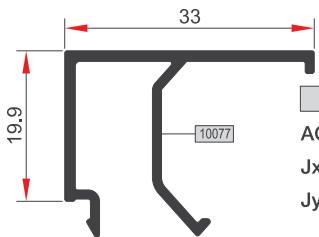

SWT55 C 12	
AĞIRLIK (kg/m) / WEIGHT kg/m	0,314
Jx (cm ⁴)	1,008
Jy (cm ⁴)	0,770

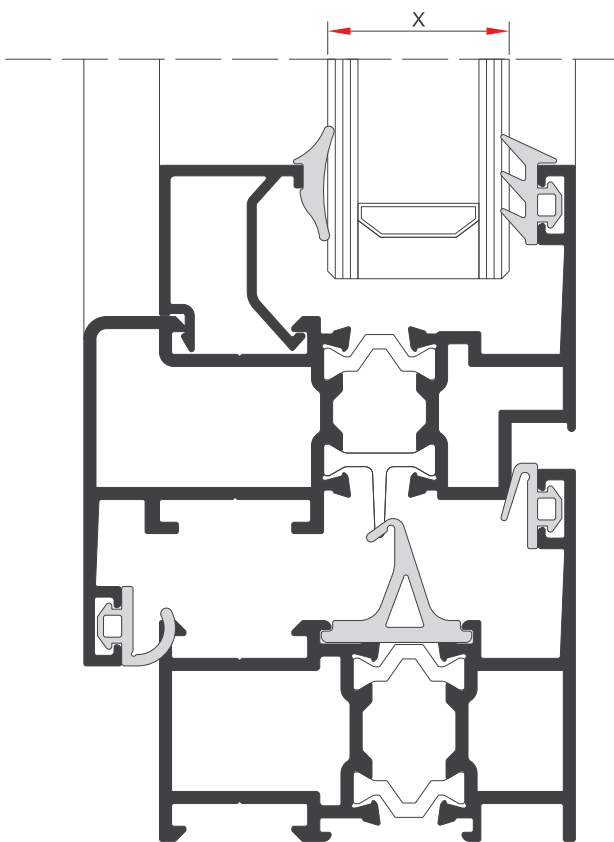

CAM TABLOSU - Glazing Table

		
	FITIL004	FITIL005
SWT55 C 01	32 mm	31 mm
SWT55 C 02	30 mm	29 mm
SWT55 C 03	28 mm	27 mm
SWT55 C 04	26 mm	25 mm
SWT55 C 05	24 mm	23 mm
SWT55 C 06	22 mm	21 mm
SWT55 C 07	20 mm	19 mm
SWT55 C 08	18 mm	17 mm
SWT55 C 09	16 mm	15 mm
SWT55 C 10	14 mm	13 mm
SWT55 C 11	12 mm	11 mm
SWT55 C 12	10 mm	9 mm
SWT55 C 13	8 mm	7 mm
SWT55 C 14	6 mm	5 mm
SWT55 C 15	4 mm	3 mm

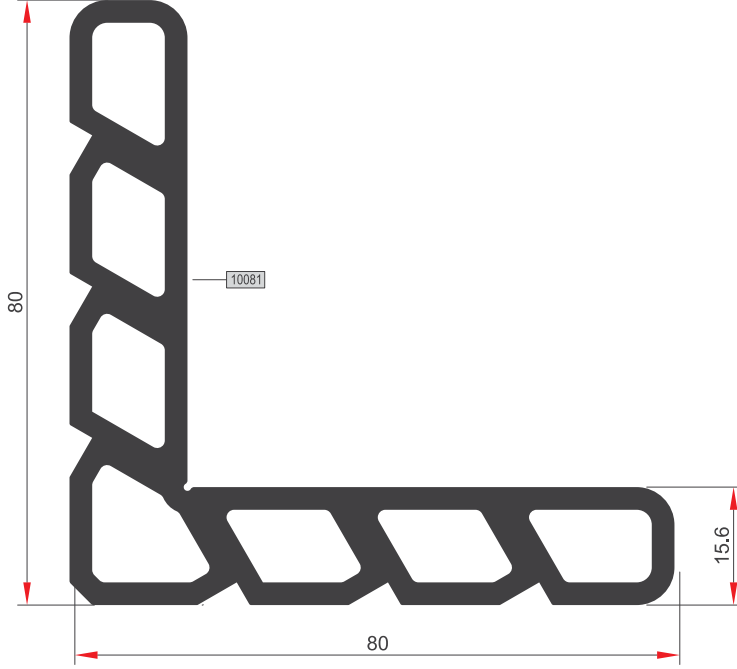

SWT55 KT 01

AĞIRLIK (kg/m) / WEIGHT kg/m	3,226
Jx (cm ⁴)	66,802
Jy (cm ⁴)	66,802

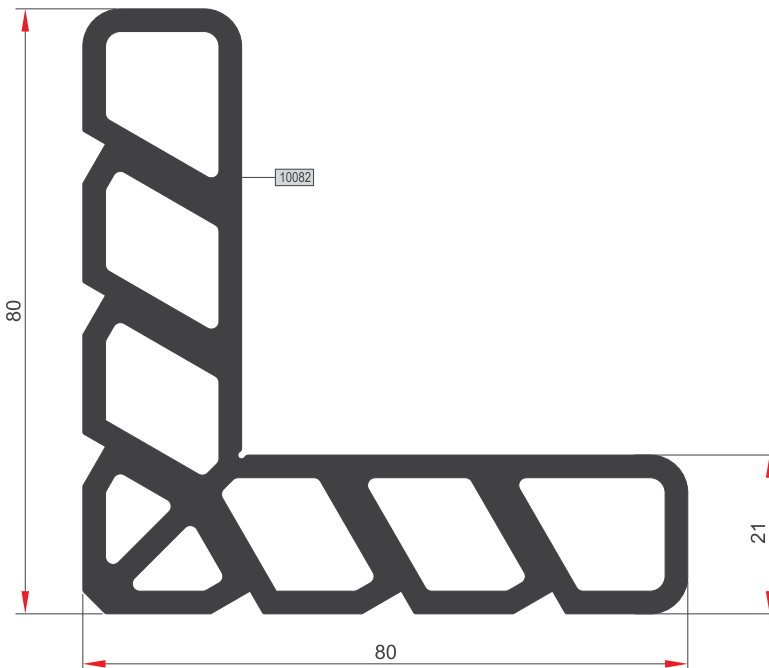

SWT55 KT 02

AĞIRLIK (kg/m) / WEIGHT kg/m	3,788
Jx (cm ⁴)	74,787
Jy (cm ⁴)	74,787

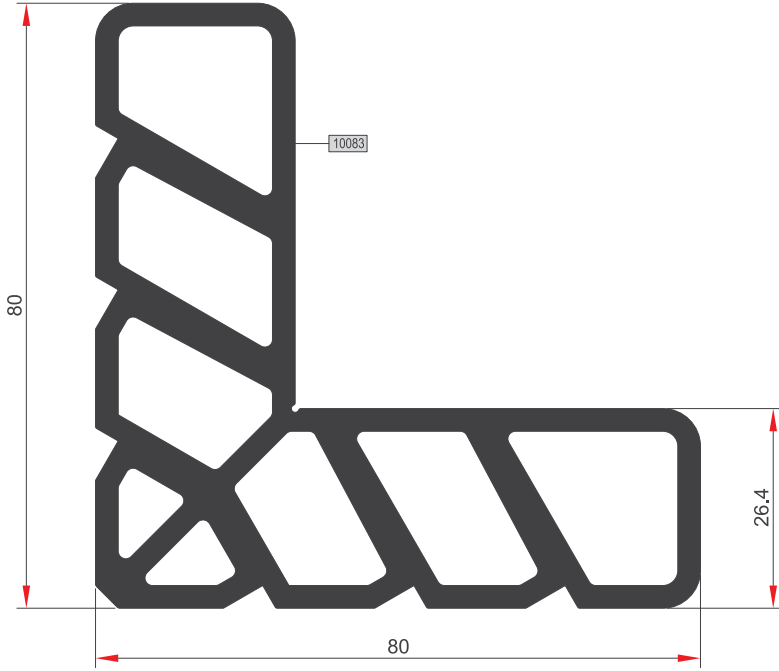

SWT55 KT 03

AĞIRLIK (kg/m) / WEIGHT kg/m	4,109
Jx (cm ⁴)	79,786
Jy (cm ⁴)	79,786

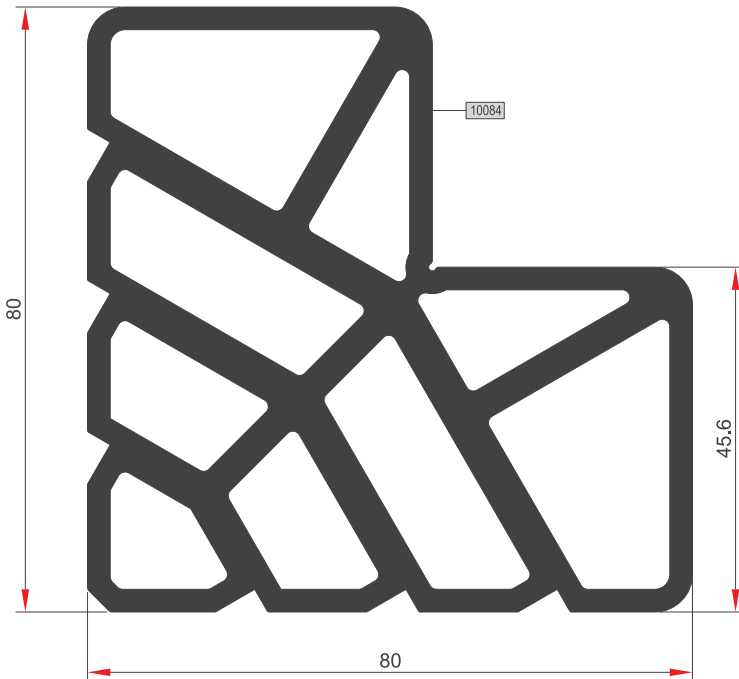

SWT55 KT 04

AĞIRLIK (kg/m) / WEIGHT kg/m	5,602
Jx (cm ⁴)	107,561
Jy (cm ⁴)	107,561

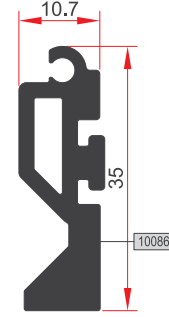
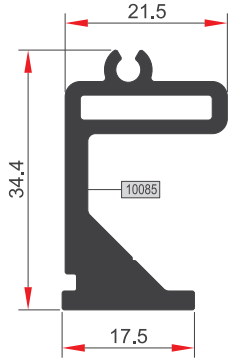

SWT55 KB 01

AĞIRLIK (kg/m) / WEIGHT kg/m	0,694
Jx (cm ⁴)	0,852
Jy (cm ⁴)	3,138

SWT55 KB 02

AĞIRLIK (kg/m) / WEIGHT kg/m	0,597
Jx (cm ⁴)	0,200
Jy (cm ⁴)	2,283

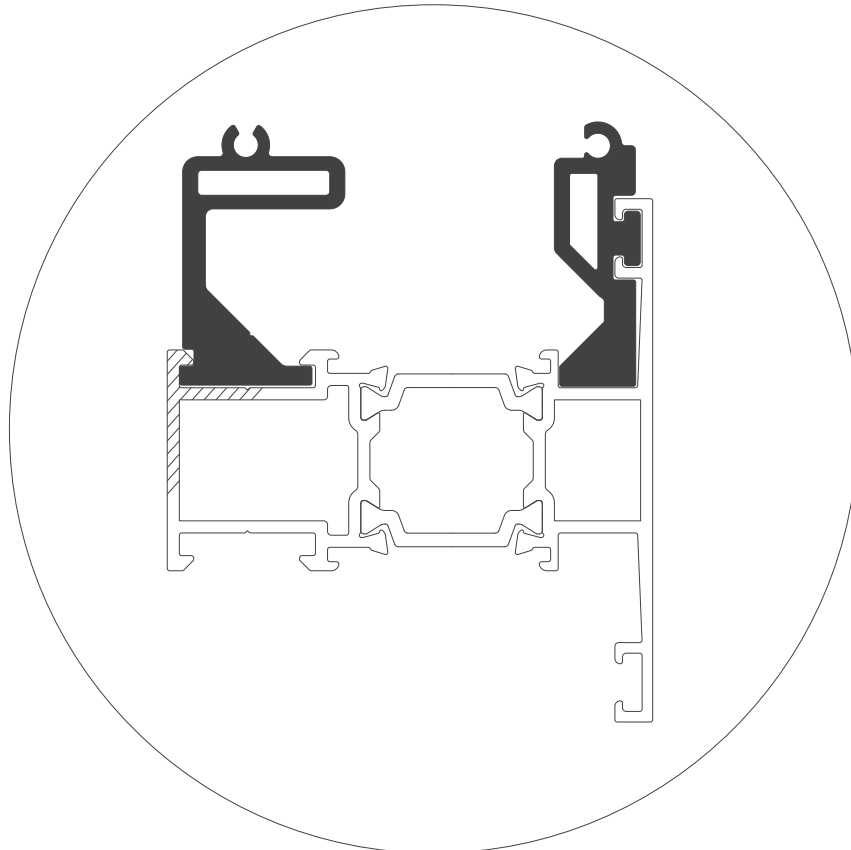

ALUSYSTEMS

Aluminyum Kapı Pencere ve Giydirme Cephe Sistemleri
Aluminium Window Doors and Facade Systems



MiMARI KATALOG

ARCHITECTURAL CATALOGUE

Aluminyum Kapı Pencere ve Giydirme Cephe Sistemleri
Aluminium Window Doors and Facade Systems



ALUSYSTEMS
Profil Detayları
ALUSYSTEMS
Profile Details

SWT55

DETAYLAR
DETAILS

ALUSYSTEMS

Aluminyum Kapı Pencere ve Giydirme Cephe Sistemleri
Aluminium Window Doors and Facade Systems



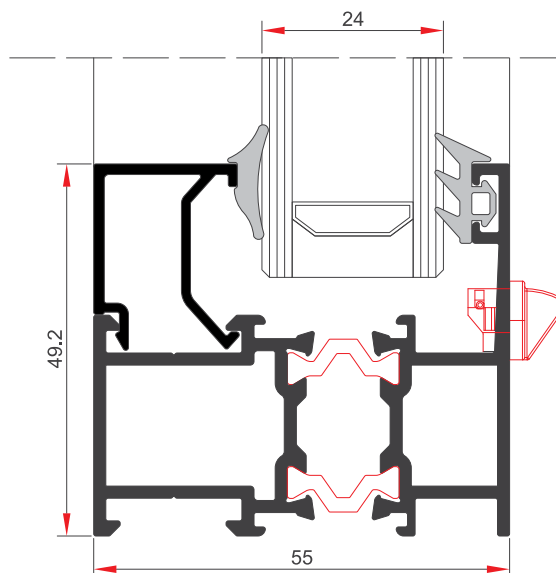
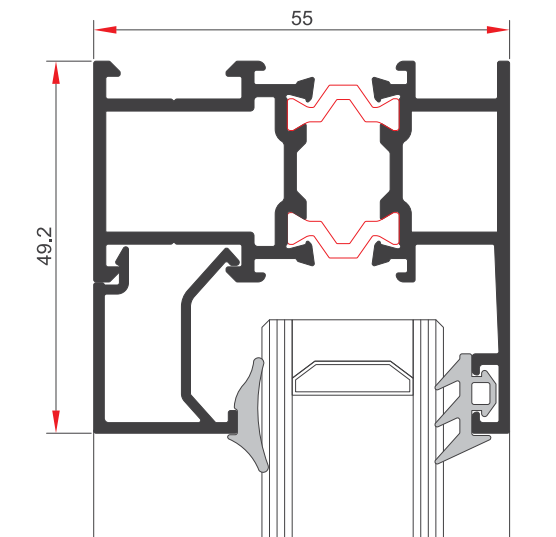
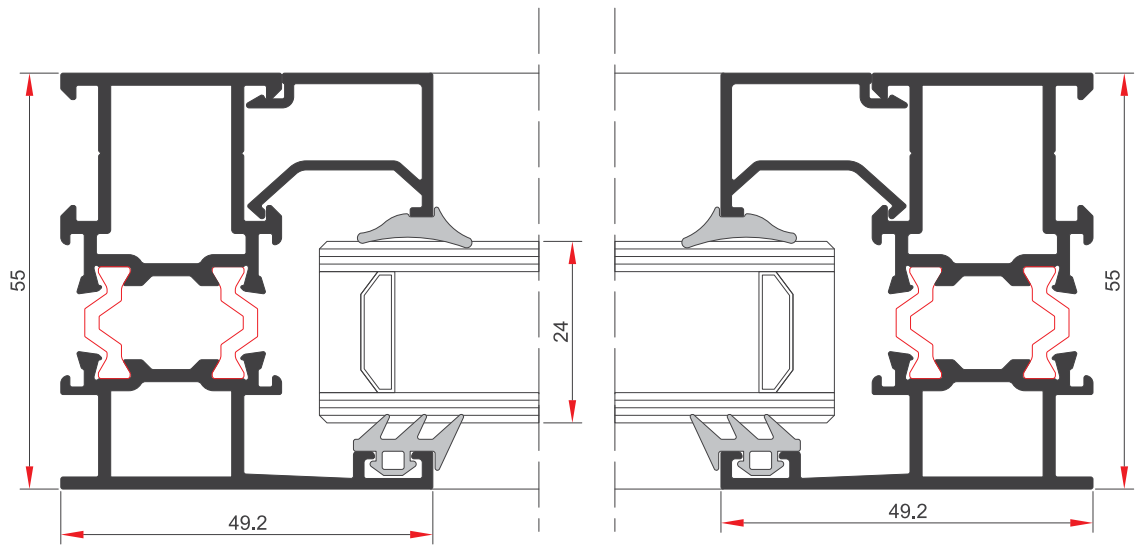

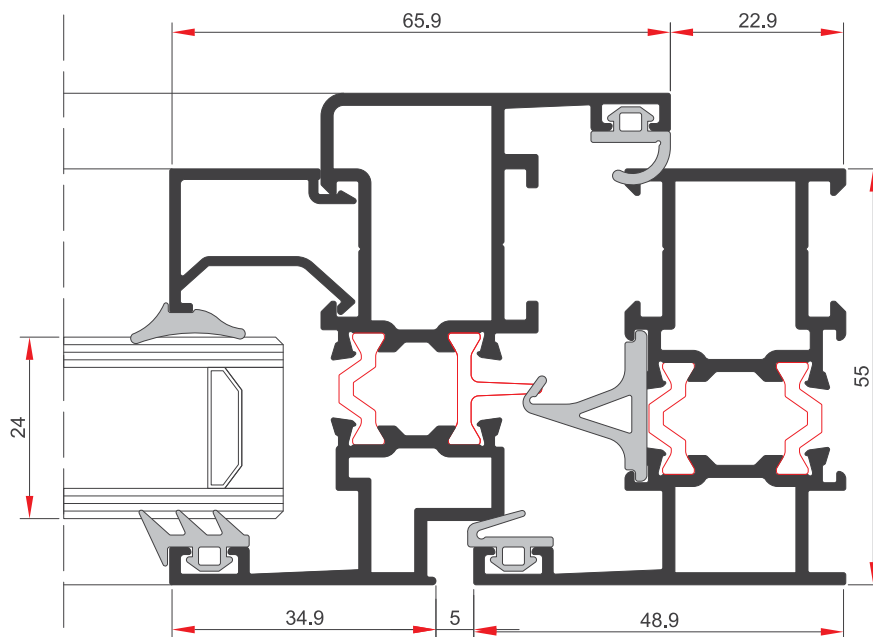
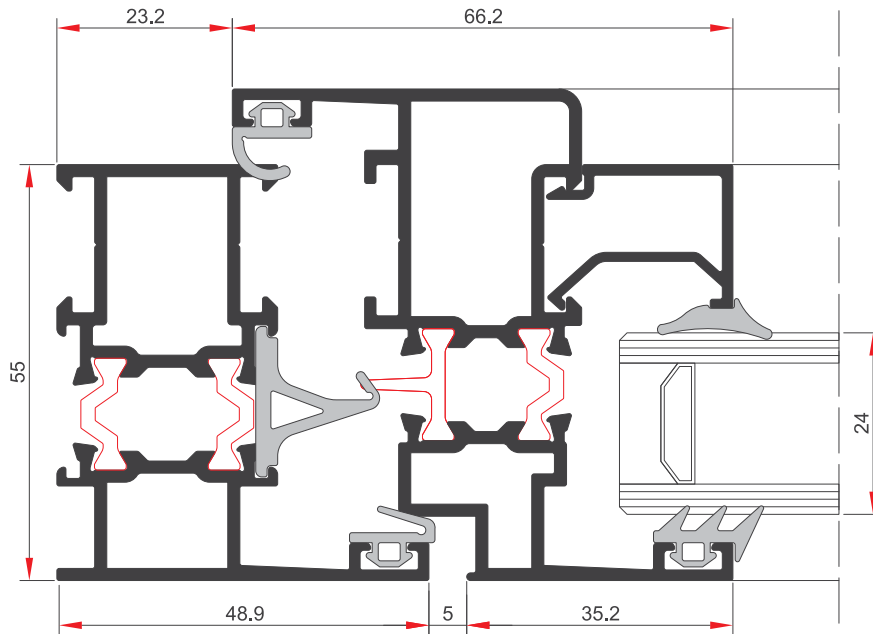

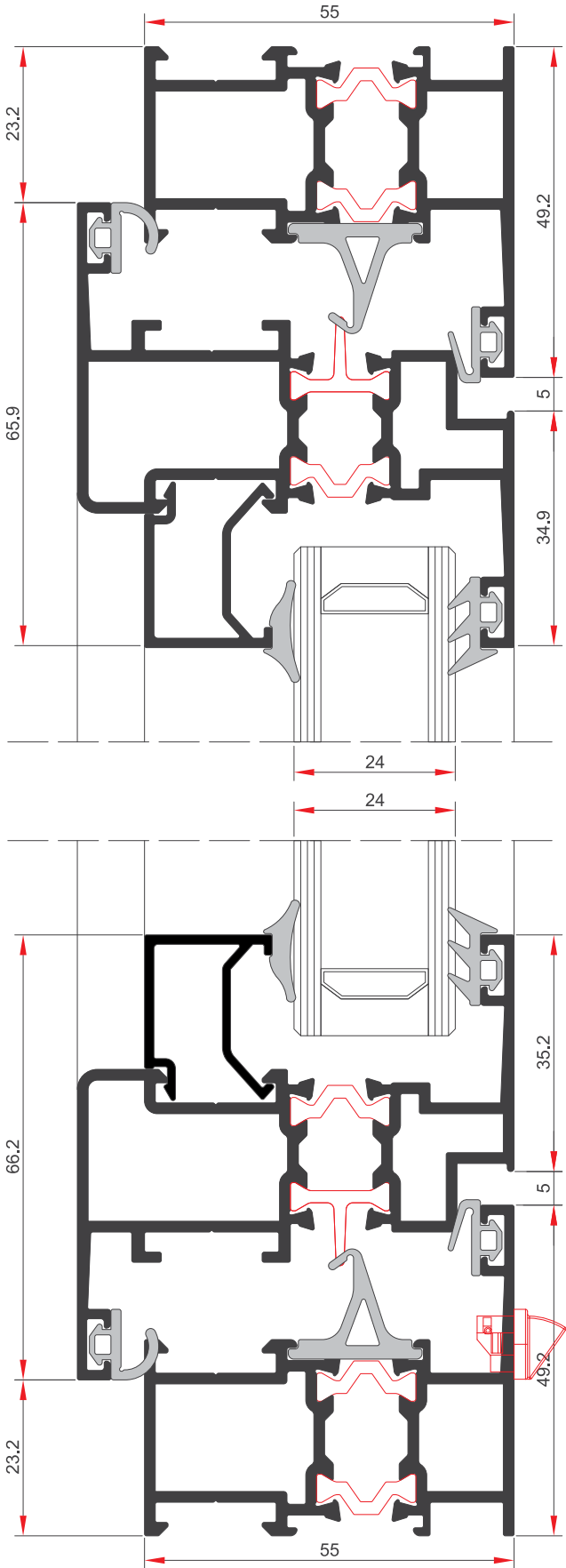

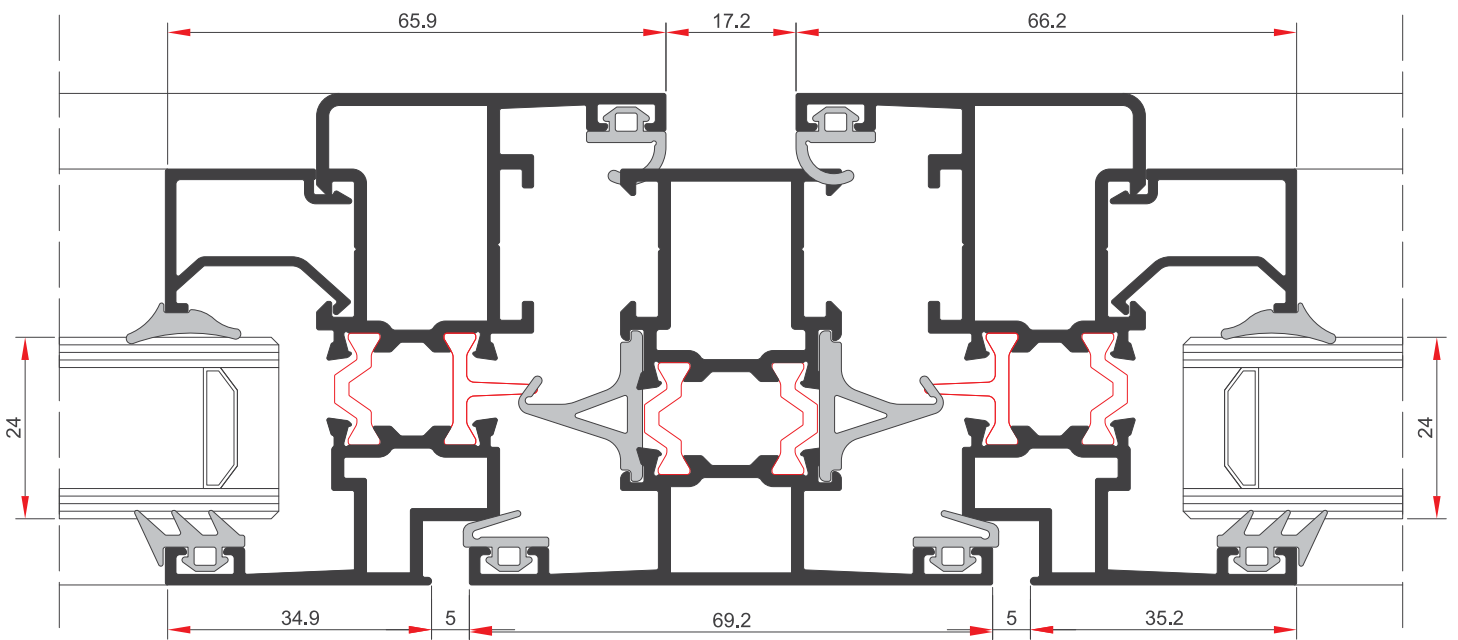
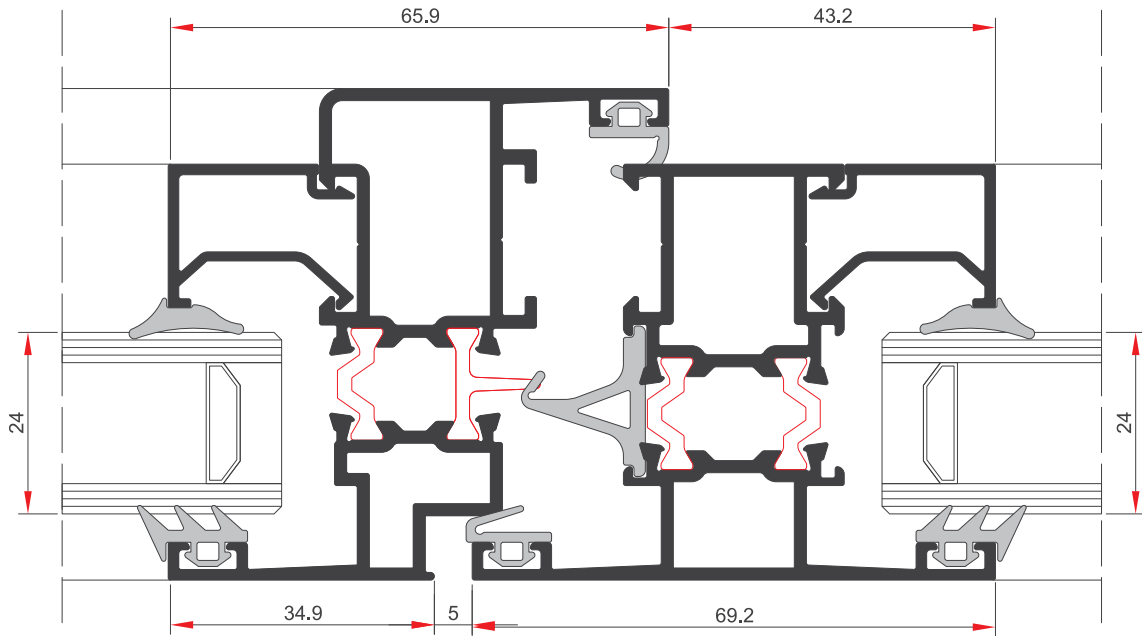

SWT55 | DETAYLAR DETAILS

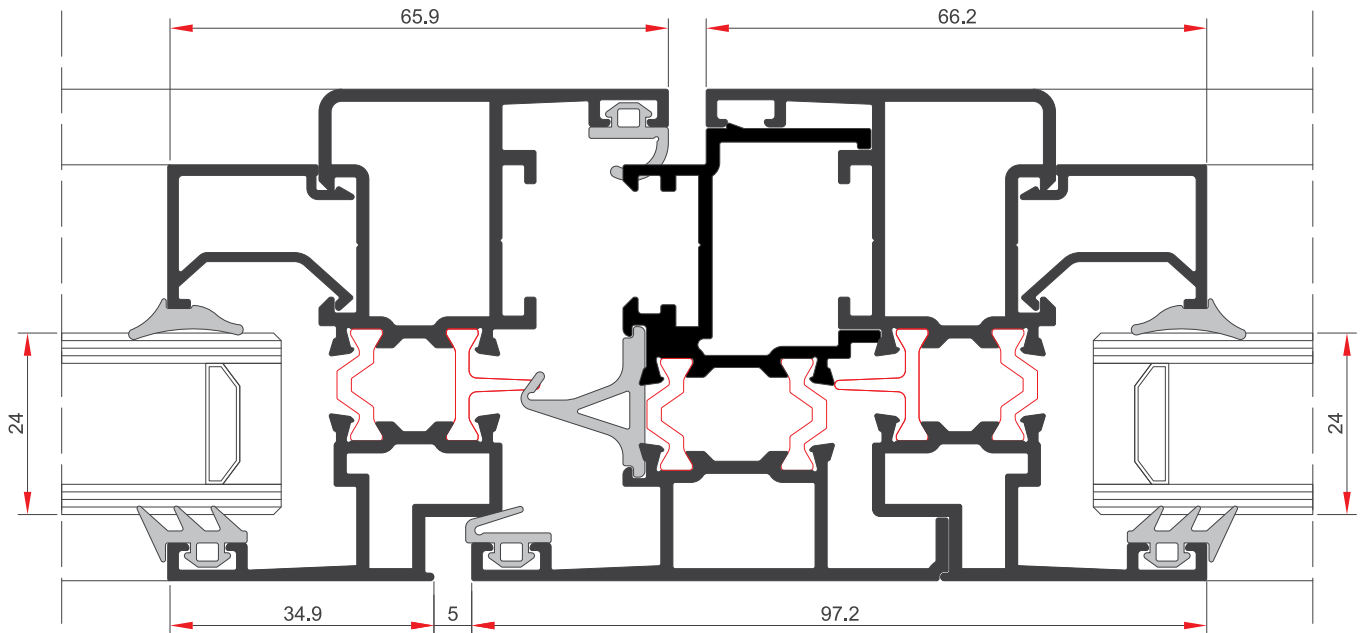

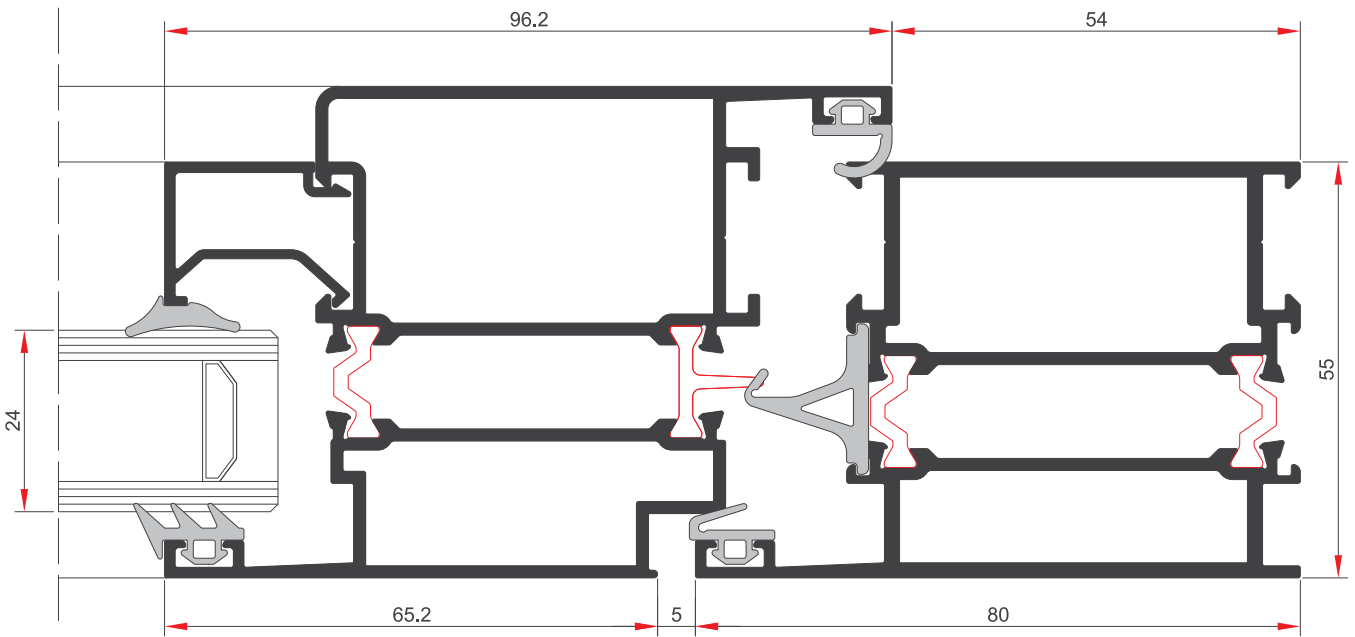
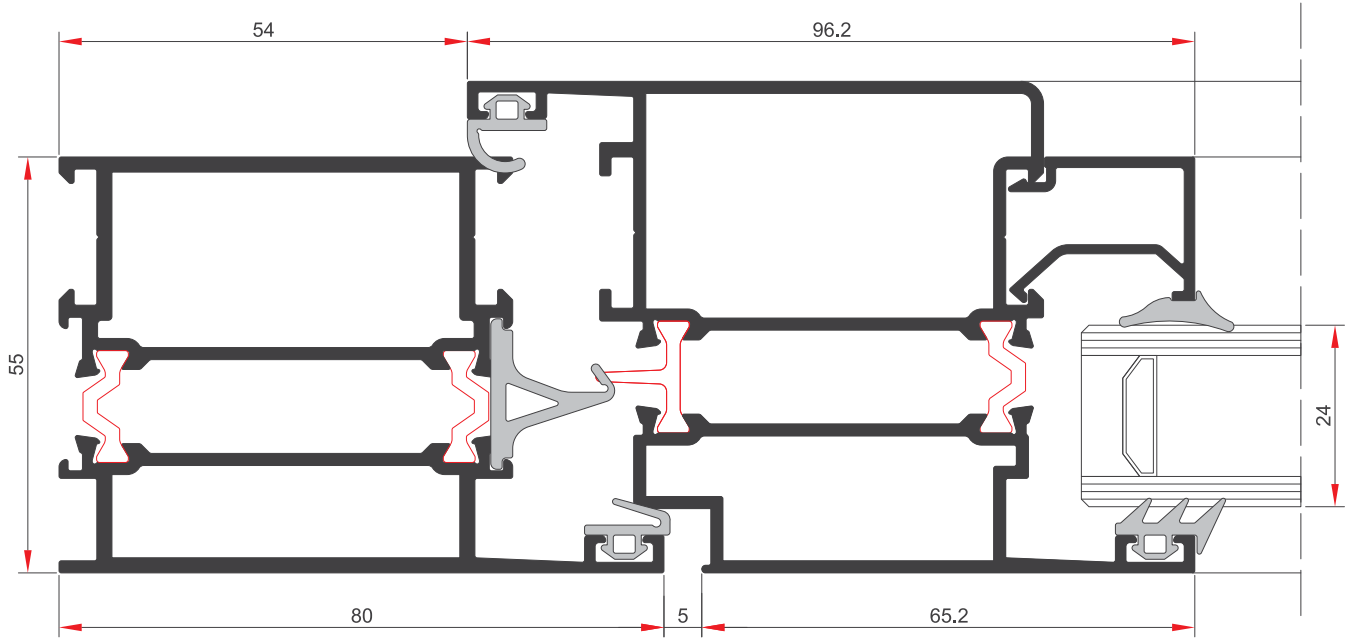

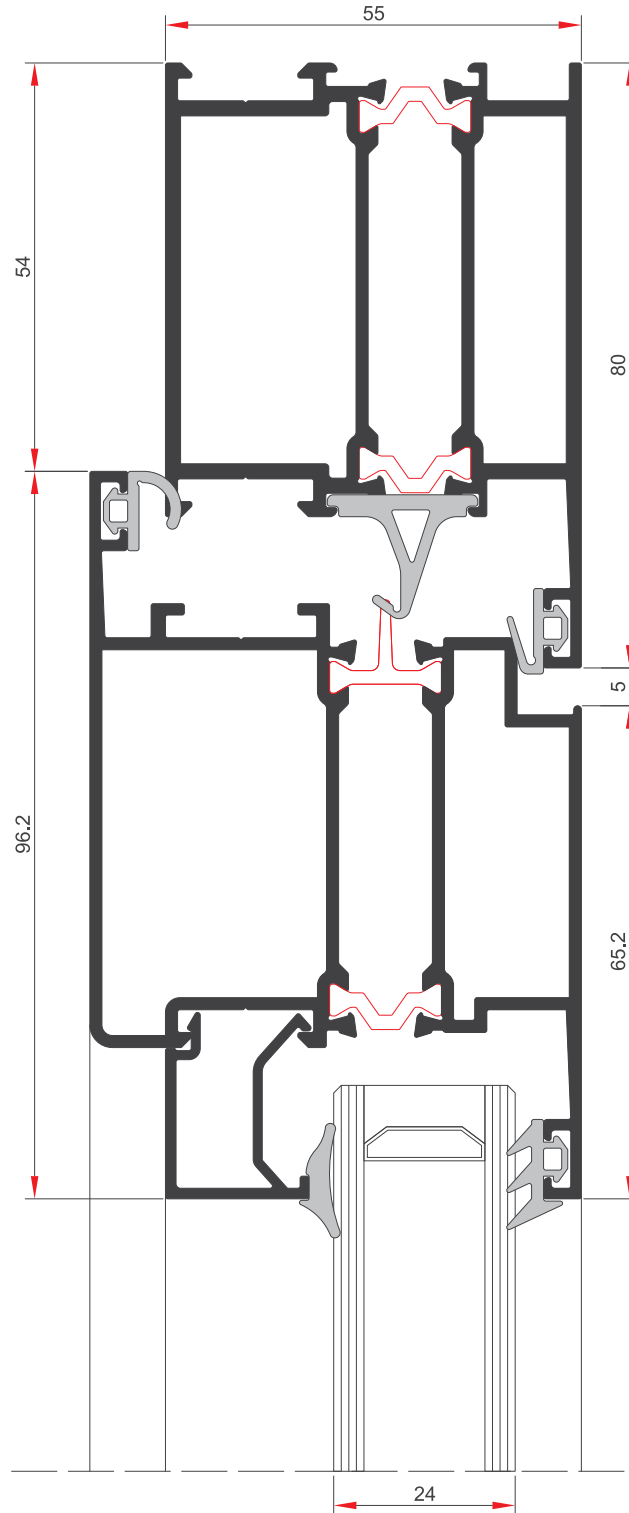

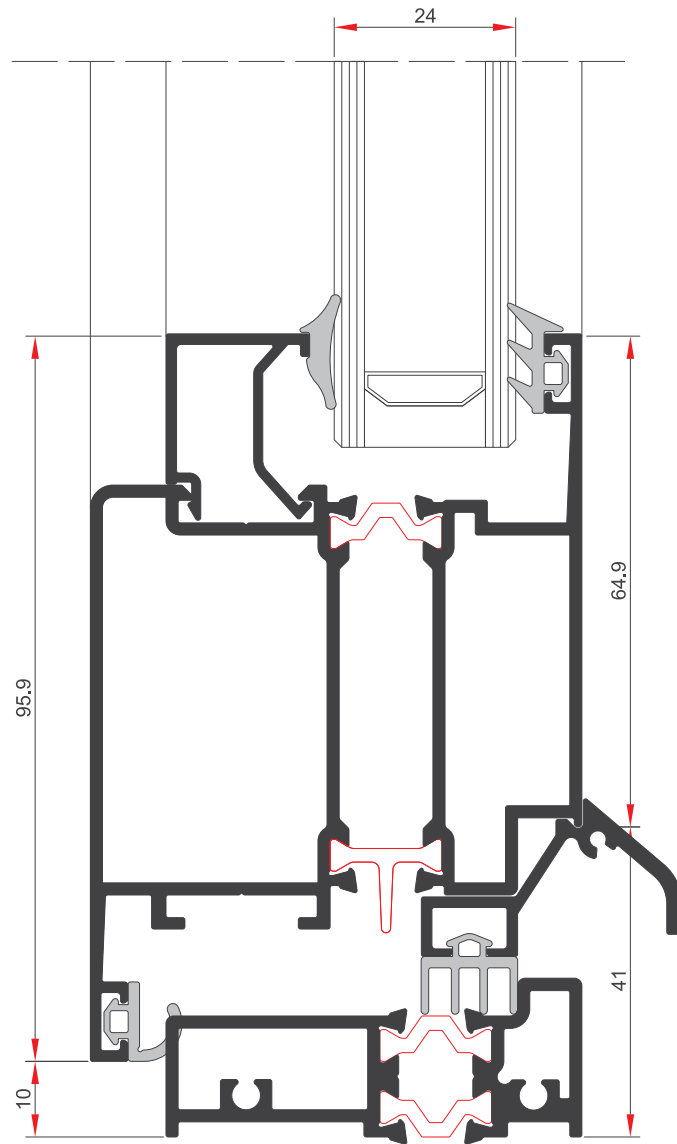

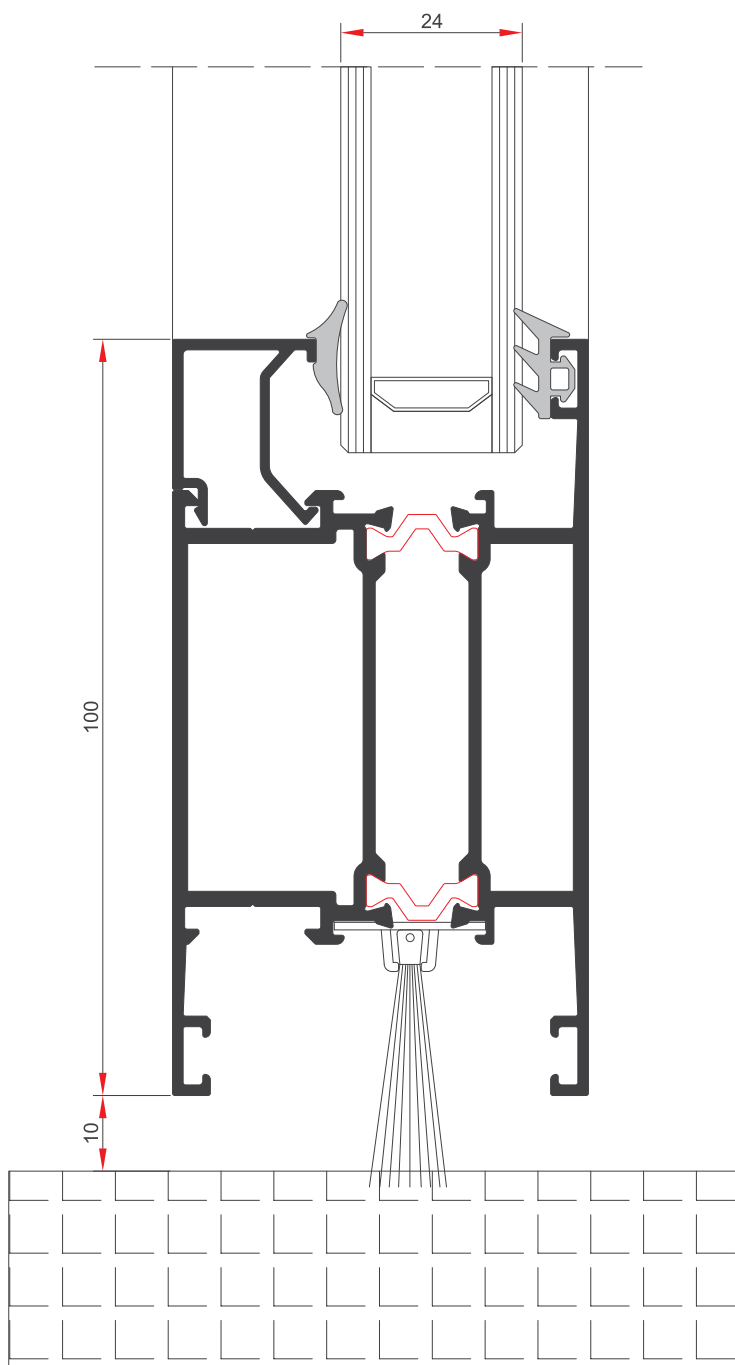

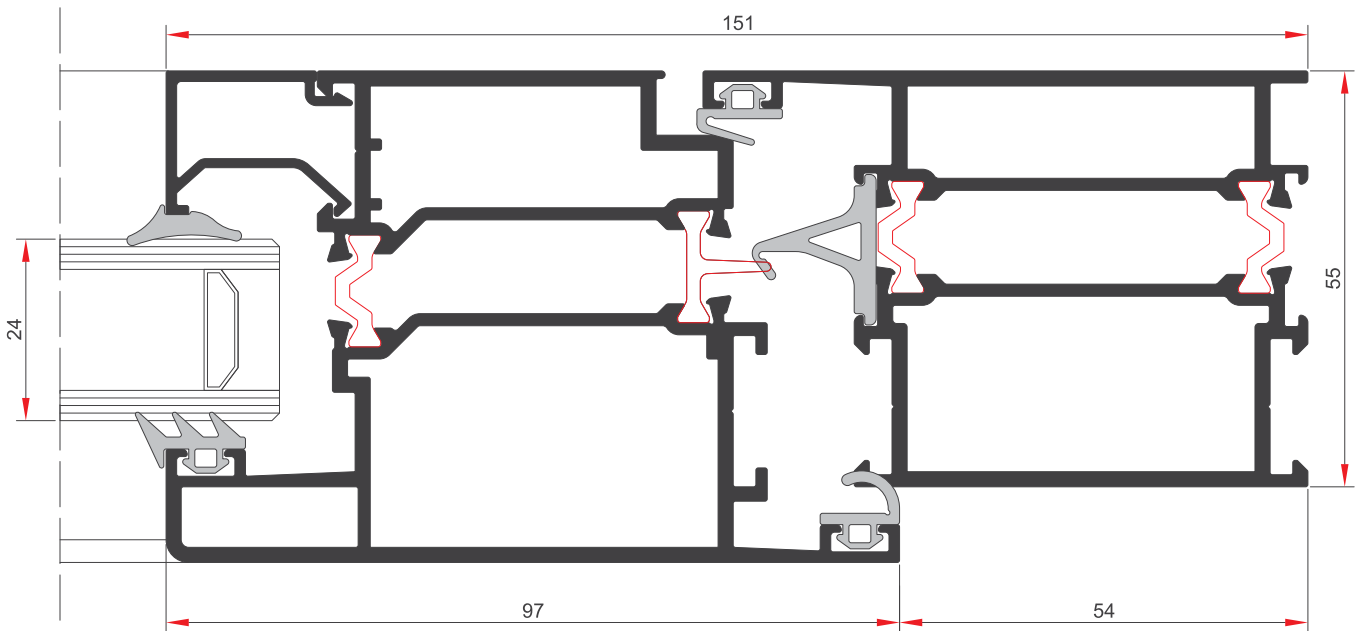
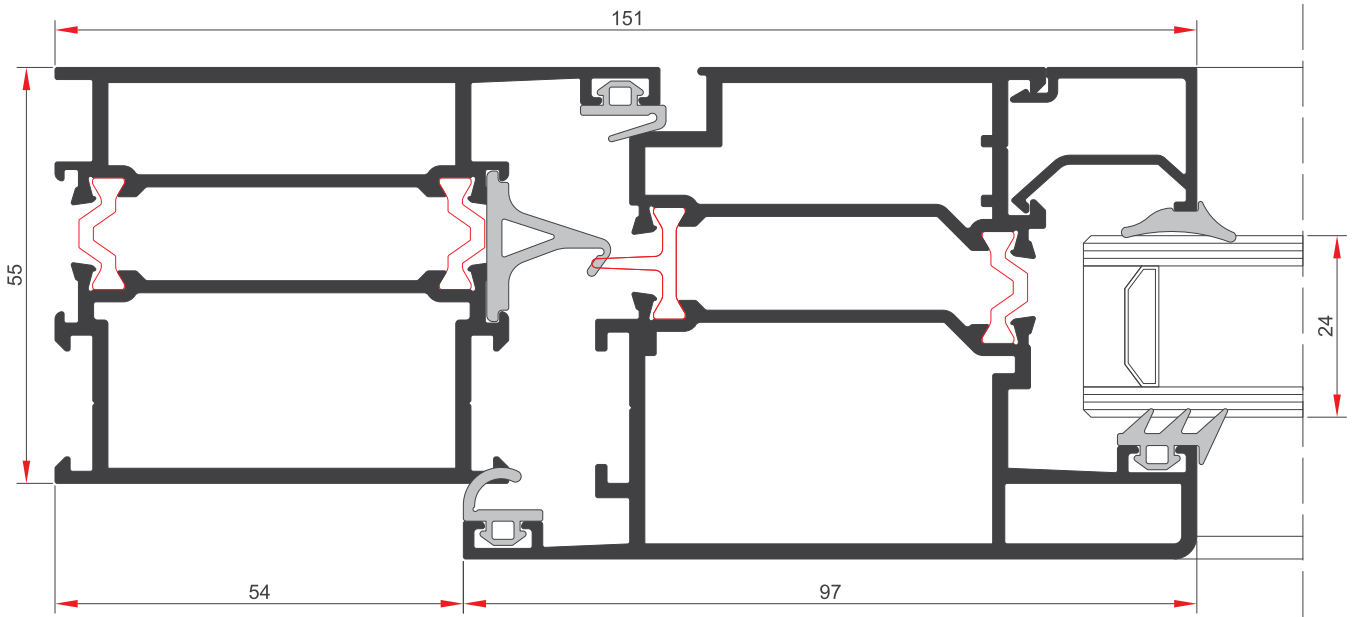

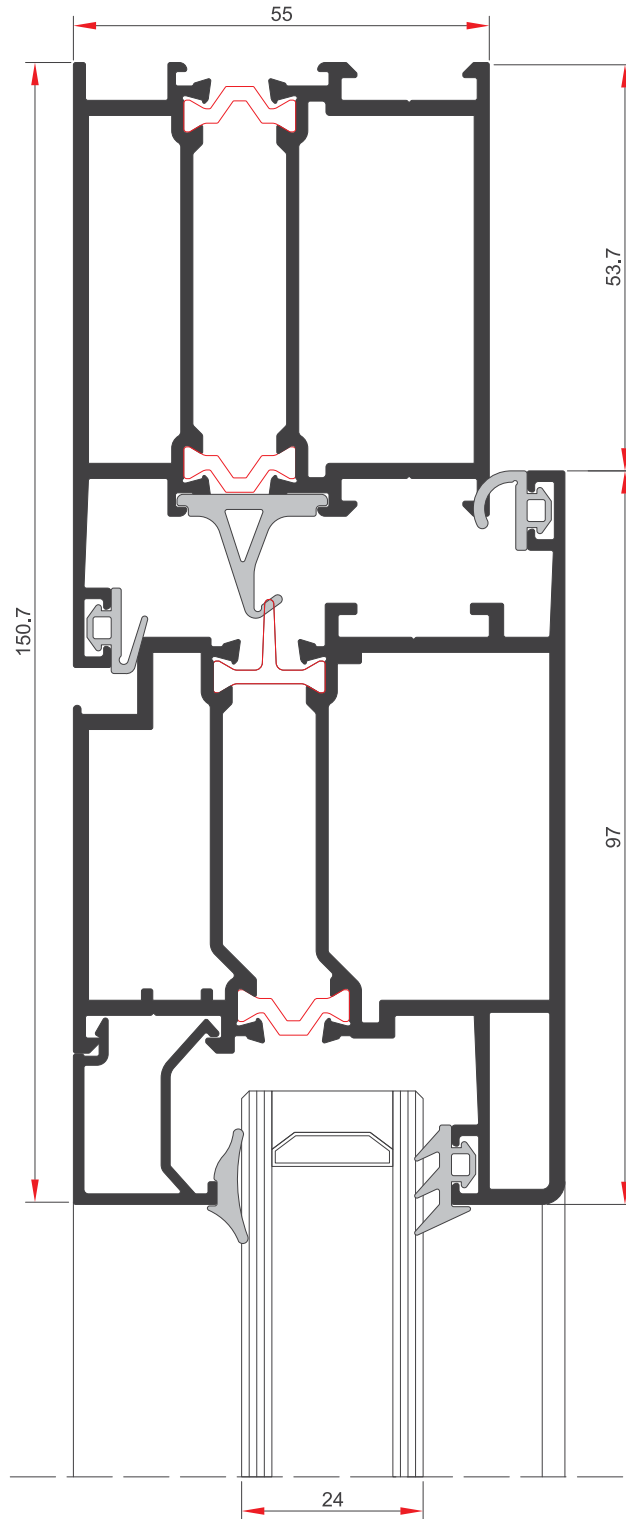

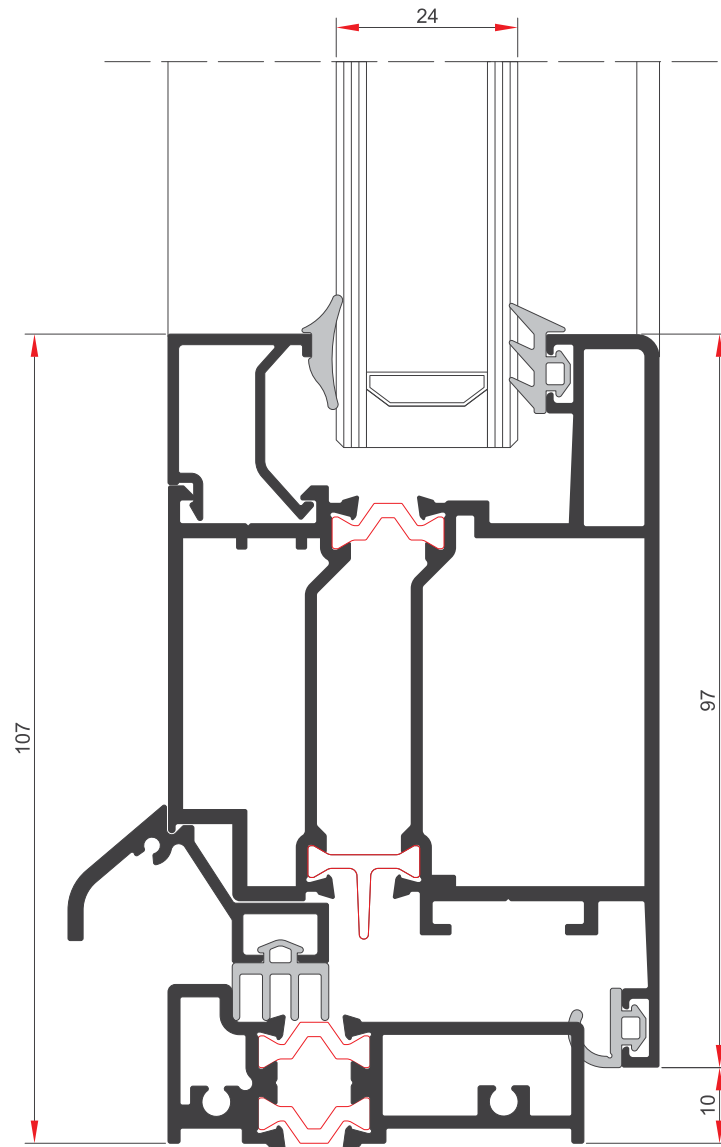

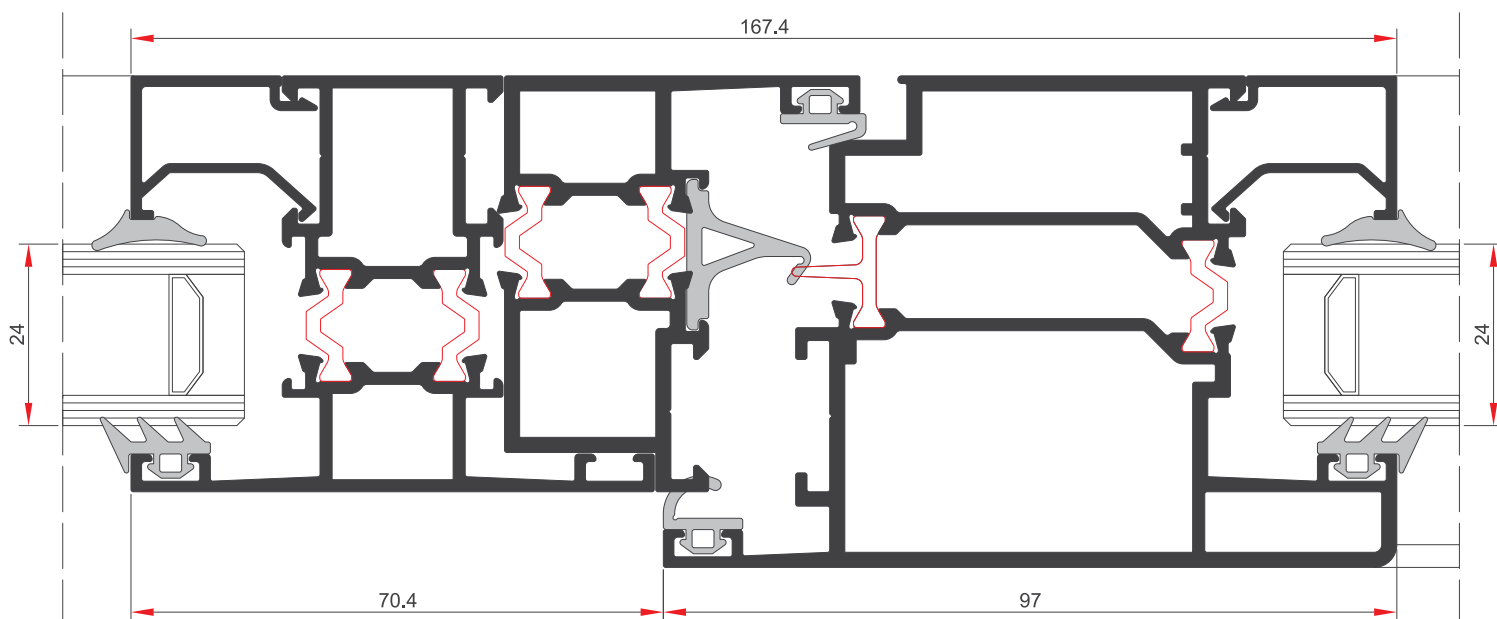
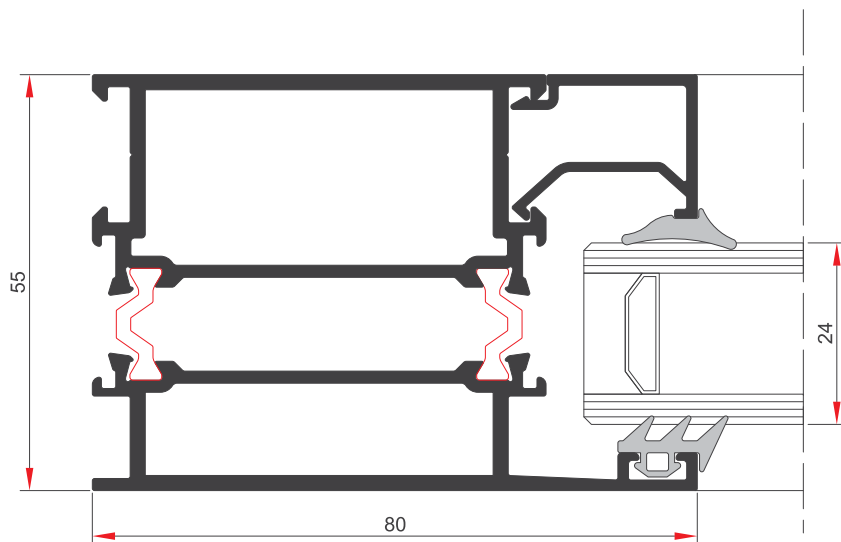

SWT55 | DETAYLAR DETAILS

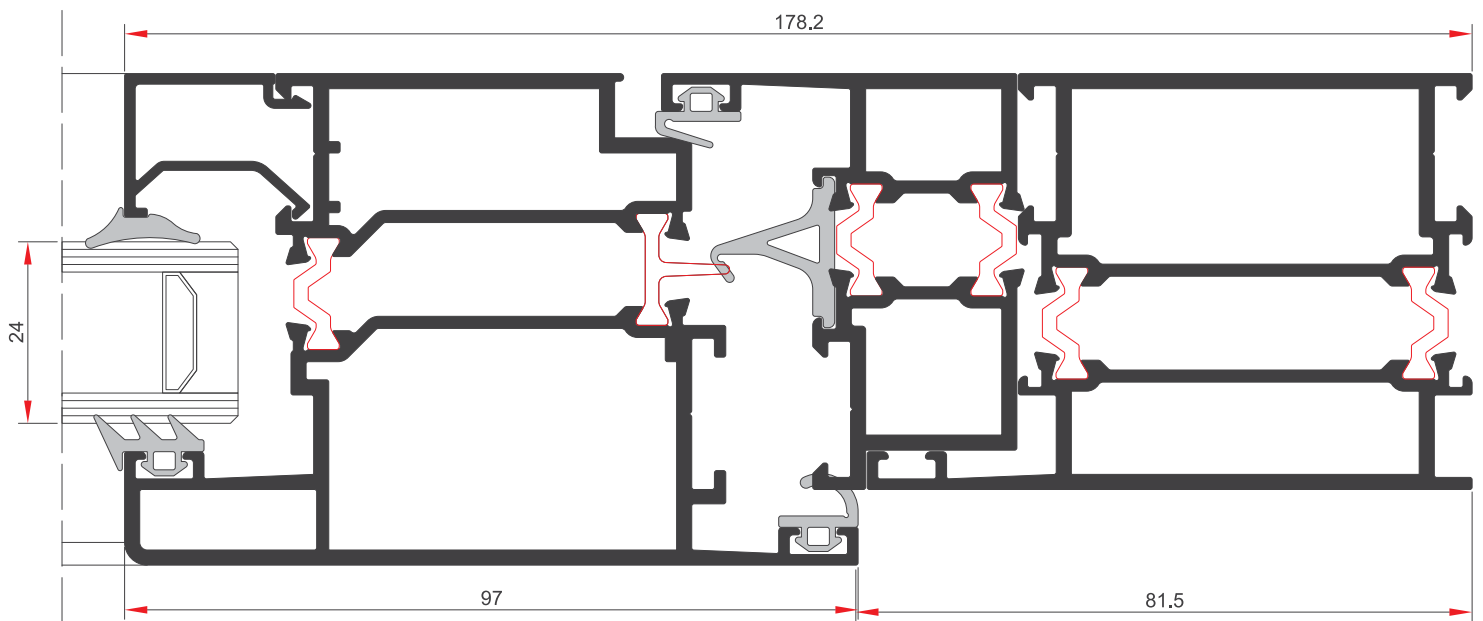

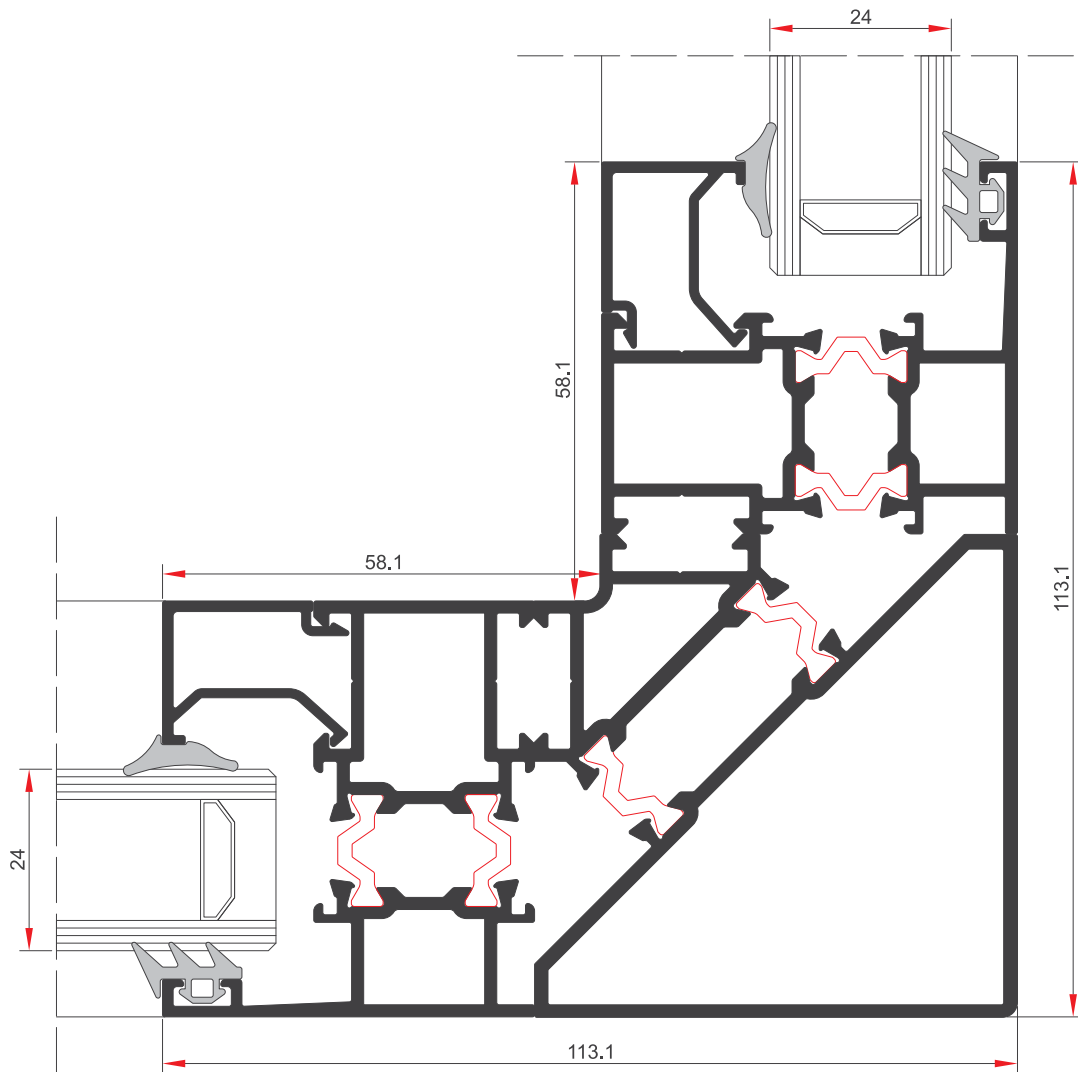

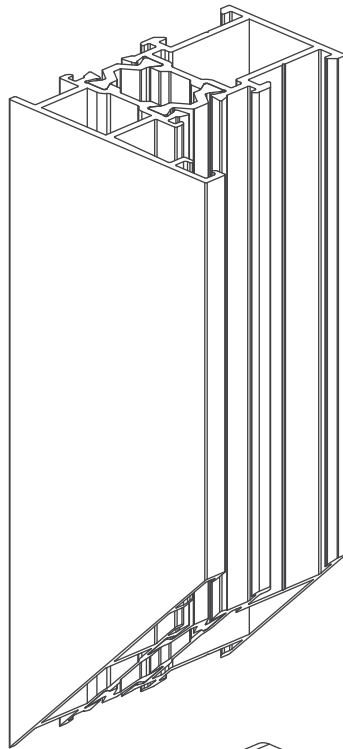

SWT55 KS XX

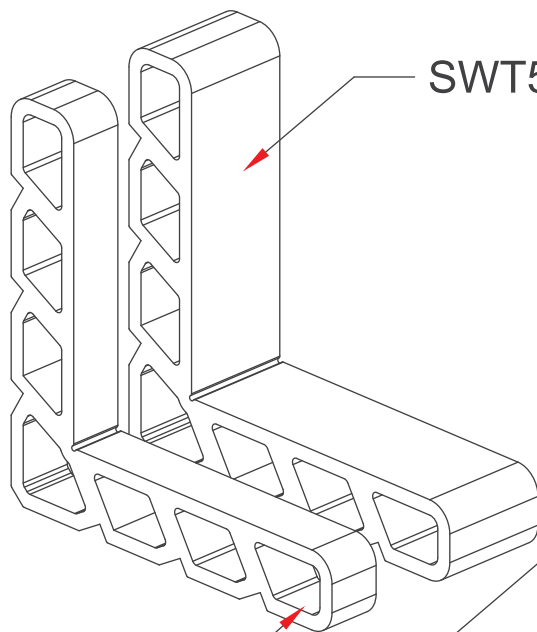

SWT55 K T XX

SWT55 KT XX

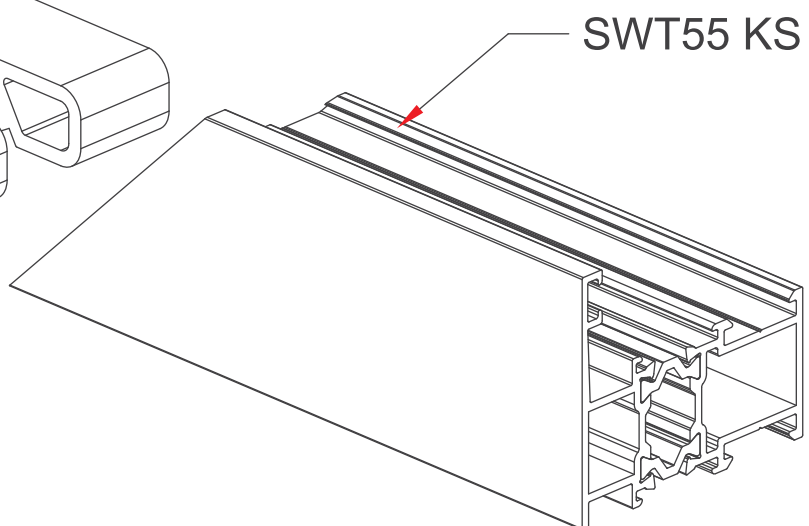

SWT55 KS XX

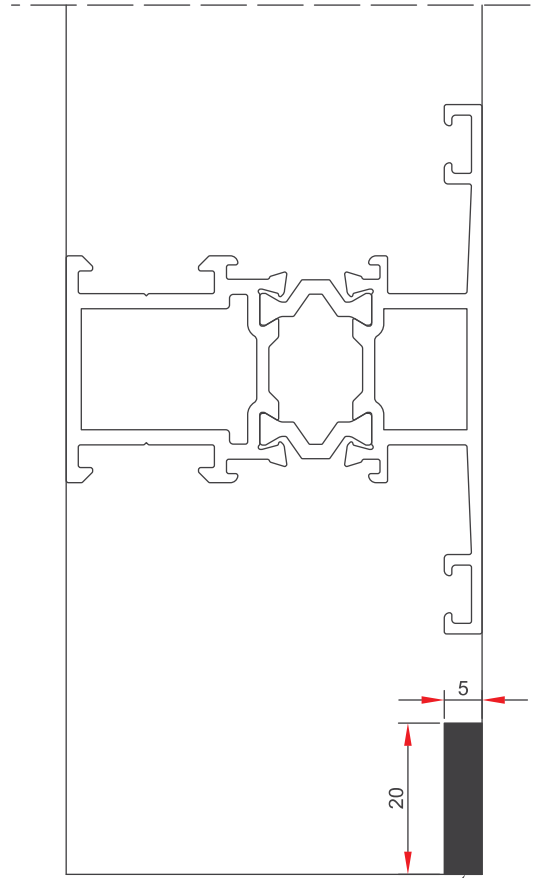
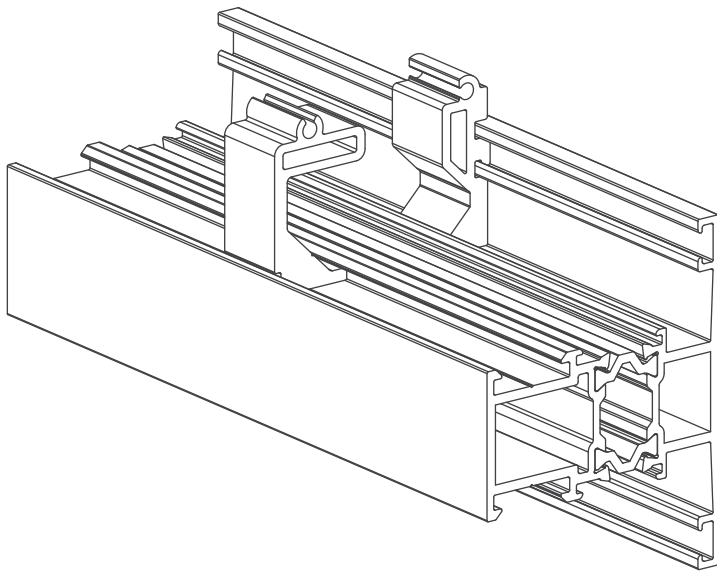
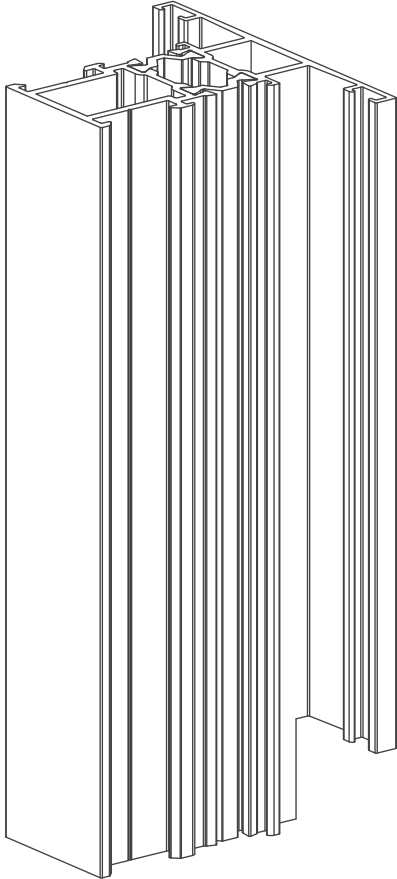

KERTME

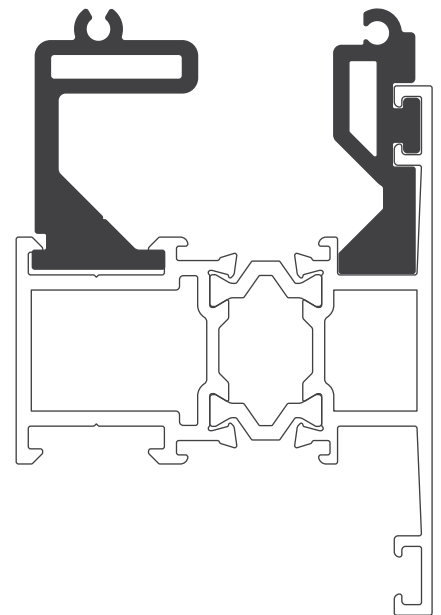

ALUSYSTEMS

Aluminyum Kapı Pencere ve Giydirme Cephe Sistemleri
Aluminium Window Doors and Facade Systems



MİMARİ KATALOG

ARCHITECTURAL CATALOGUE

Aluminyum Kapı Pencere ve Giydirme Cephe Sistemleri
Aluminium Window Doors and Facade Systems



ALUSYSTEMS
Profil Detayları

ALUSYSTEMS
Profile Details

SWT55

AKSESUARLAR
ACCESSORIES

ALUSYSTEMS



Aluminyum Kapı Pencere ve Giydirme Cephe Sistemleri
Aluminium Window Doors and Facade Systems





FITIL001		<p>DIŐ CAM FİTİLİ GLAZING GASKET (OUTSIDE)</p> <p>Malzeme/ Material : EPDM Ağırlık/ Weight : 61 gr/m Paket/ Package: 245 m / 15 kg</p>	
FITIL002		<p>DIŐ BİNİ FİTİLİ SEALING GASKET (OUTSIDE)</p> <p>Malzeme/ Material : EPDM Ağırlık/ Weight : 40 gr/m Paket/ Package: 375 m / 15 kg</p>	
FITIL003		<p>İÇ BİNİ FİTİLİ SEALING GASKET (INSIDE)</p> <p>Malzeme/ Material : EPDM Ağırlık/ Weight : 50 gr/m Paket/ Package: 300 m / 15 kg</p>	
FITIL004		<p>KAMA FİTİLİ GLAZING GASKET (INSIDE)</p> <p>Malzeme/ Material : EPDM Ağırlık/ Weight : 46 gr/m Paket/ Package: 326 m / 15 kg</p>	
FITIL005		<p>KAMA FİTİLİ GLAZING GASKET (INSIDE)</p> <p>Malzeme/ Material : EPDM Ağırlık/ Weight : 56 gr/m Paket/ Package: 268 m / 15 kg</p>	

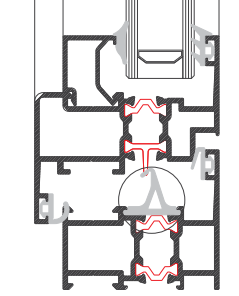

FITIL006		<p>TOZLUK FİTİLİ CENTRAL GASKET</p> <p>Malzeme/ Material : EPDM Ağırlık/ Weight : 117 gr/m Paket/ Package: 128 m / 15 kg</p>	
FITIL007		<p>EŞİK FİTİLİ THRESHOLD GASKET</p> <p>Malzeme/ Material : EPDM Ağırlık/ Weight : 66 gr/m Paket/ Package: 227 m / 15 kg</p>	