



**109-158**  
**SW55**

# ALUSYSTEMS

Aluminyum Kapı Pencere ve Giydirme Cephe Sistemleri  
Aluminium Window Doors and Facade Systems



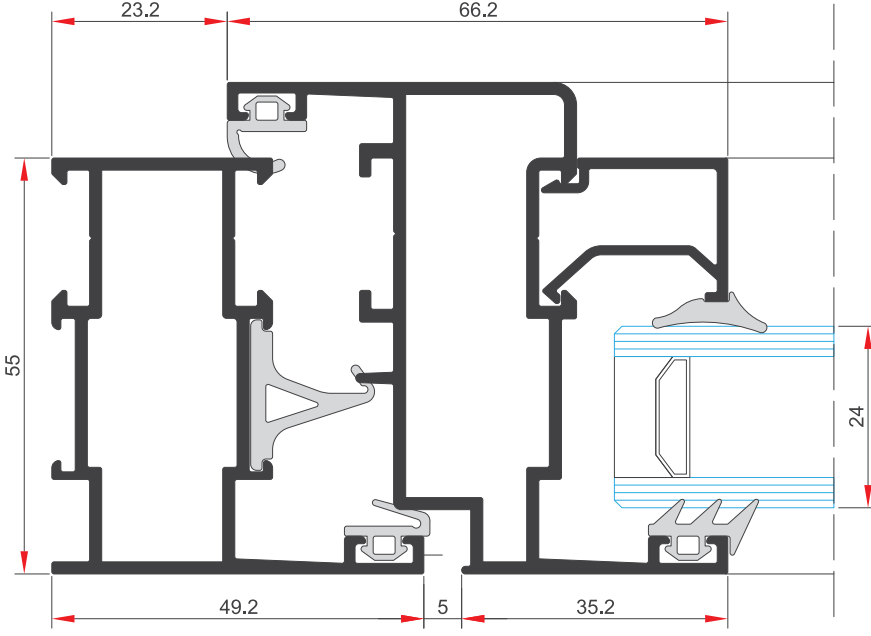

## TEKNİK DETAYLAR | TECHNICAL DETAILS



**KASA GENİRLİĞİ :** 55 MM  
**FRAME WIDTH :** 55 MM



**ISI BARIYERİ :** ----  
**HEAT BARRIER :** ----



**ET KALINLIĞI :** 1.3 MM - 1.6 MM - 1.8 MM - 2 MM  
**WALL THICKNESS :** 1.3 MM - 1.6 MM - 1.8 MM - 2 MM



**CAM KALINLIĞI :** 4 MM ~ 32 MM  
**GLASS THICKNESS :** 4 MM ~ 32 MM



**AKSESUAR KANAL TİPİ :** EUROGROOVE 1 KANALA UYGUN - PVC KANAL (9 AKS) UYGUN KANATLAR  
**ACCESSORY CHANNEL TYPE :** EUROGROOVE SUITABLE FOR 1 CHANNEL - PVC (9 AXLES) SUITABLE WINGS



**AÇILIM ÇEŞİTLERİ :** TEK AÇILIM PENCERE, ÇİFT AÇILIM PENCERE, VASİSTAS AÇILIM, İÇE AÇILIR TEK KANAT KAPI, İÇE AÇILIR ÇİFT KANAT KAPI, KATLANIR KAPI, PARALEL SÜRME, DİŐA AÇILIM KAPI  
**EXPANSION TYPES :** SINGLE OPENING WINDOW, DOUBLE OPENING WINDOW, VASISTA OPENING, INWARD OPENING SINGLE WING DOOR, INWARD OPENING DOUBLE WING DOOR, FOLDING DOOR, PARALLEL SLIDING, OUTWARD OPENING DOOR

# ALUSYSTEMS

Aluminyum Kapı Pencere ve Giydirme Cephe Sistemleri  
Aluminium Window Doors and Facade Systems



# MiMARI KATALOG

## ARCHITECTURAL CATALOGUE

Aluminyum Kapı Pencere ve Giydirme Cephe Sistemleri  
Aluminium Window Doors and Facade Systems



ALUSYSTEMS  
Profil Detayları  
ALUSYSTEMS  
Profile Details

# SW55

PROFİLLER  
PROFILES



# ALUSYSTEMS

Aluminyum Kapı Pencere ve Giydirme Cephe Sistemleri  
Aluminium Window Doors and Facade Systems



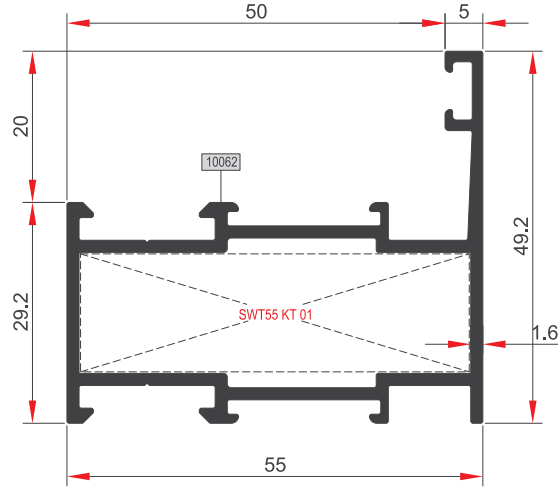

### SW55 KS 01

AĞIRLIK (kg/m) / WEIGHT kg/m	0.945
Jx (cm <sup>4</sup> )	13.837
Jy (cm <sup>4</sup> )	5.569

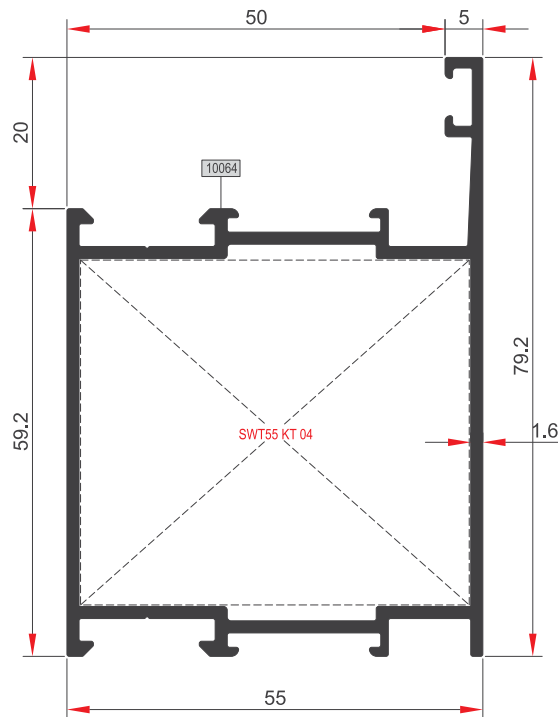

### SW55 KS 03

AĞIRLIK (kg/m) / WEIGHT kg/m	1.204
Jx (cm <sup>4</sup> )	20.748
Jy (cm <sup>4</sup> )	25.694



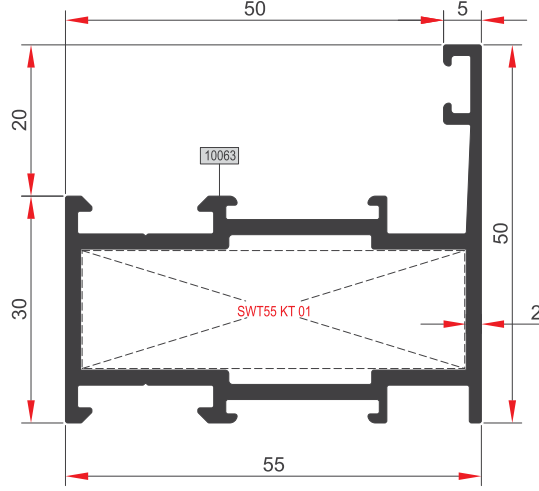

### SW55 KS 02

AĞIRLIK (kg/m) / WEIGHT kg/m	1.106
Jx (cm <sup>4</sup> )	15.863
Jy (cm <sup>4</sup> )	6.319

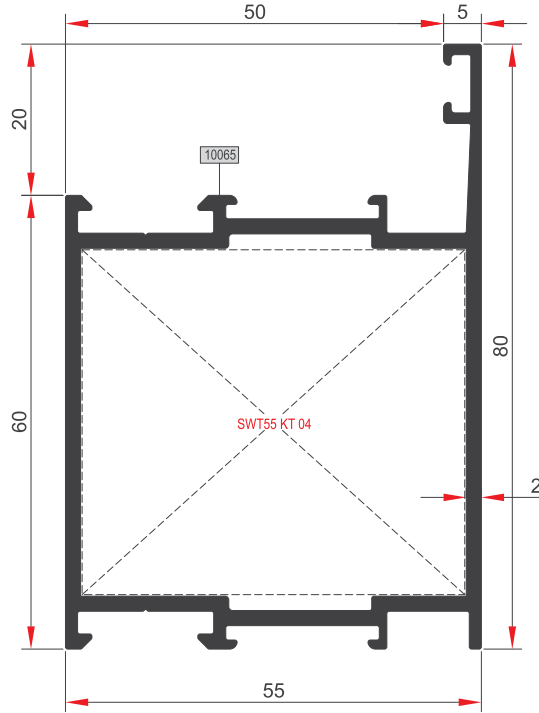

### SW55 KS 03

AĞIRLIK (kg/m) / WEIGHT kg/m	1.430
Jx (cm <sup>4</sup> )	24.354
Jy (cm <sup>4</sup> )	29.794



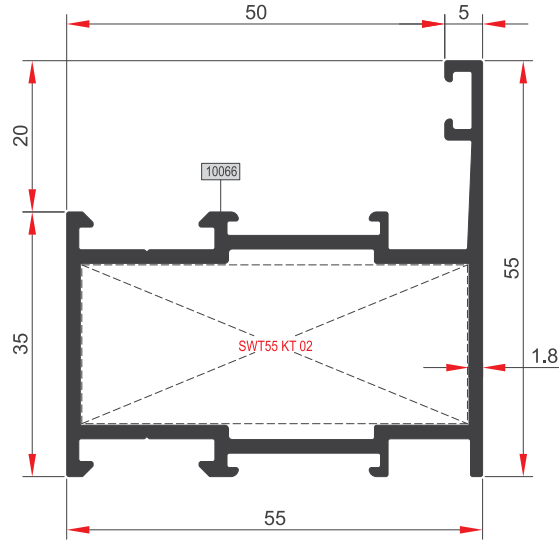

**SW55 KS 05**

AĞIRLIK (kg/m) / WEIGHT kg/m	1.078
Jx (cm <sup>4</sup> )	16.245
Jy (cm <sup>4</sup> )	8.465

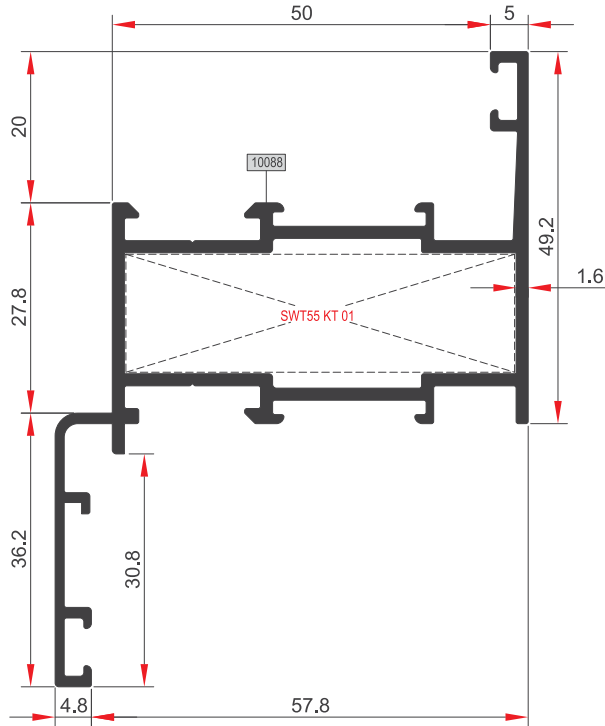

**SW55 KS 07**

AĞIRLIK (kg/m) / WEIGHT kg/m	1.153
Jx (cm <sup>4</sup> )	21.887
Jy (cm <sup>4</sup> )	13.532

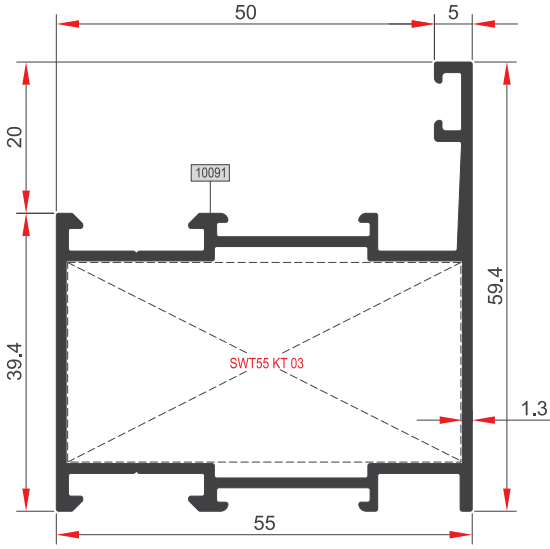

**SW55 KS 09**

AĞIRLIK (kg/m) / WEIGHT kg/m	0.899
Jx (cm <sup>4</sup> )	14.342
Jy (cm <sup>4</sup> )	9.612

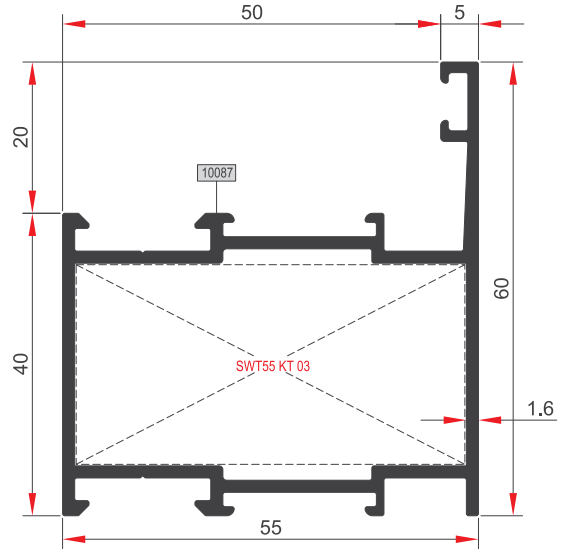

**SW55 KS 06**

AĞIRLIK (kg/m) / WEIGHT kg/m	1.038
Jx (cm <sup>4</sup> )	16.329
Jy (cm <sup>4</sup> )	10.781

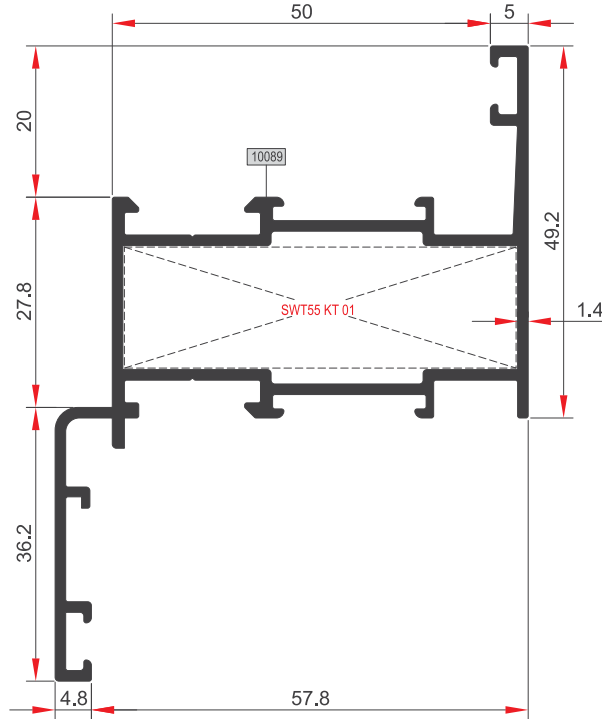

**SW55 KS 08**

AĞIRLIK (kg/m) / WEIGHT kg/m	1.089
Jx (cm <sup>4</sup> )	21.373
Jy (cm <sup>4</sup> )	13.849

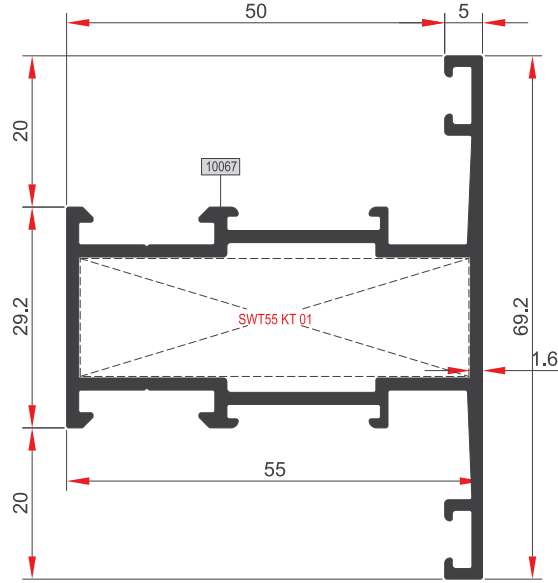

**SW55 KY 01**

AĞIRLIK (kg/m) / WEIGHT kg/m	1.064
Jx (cm <sup>4</sup> )	15.913
Jy (cm <sup>4</sup> )	8.911

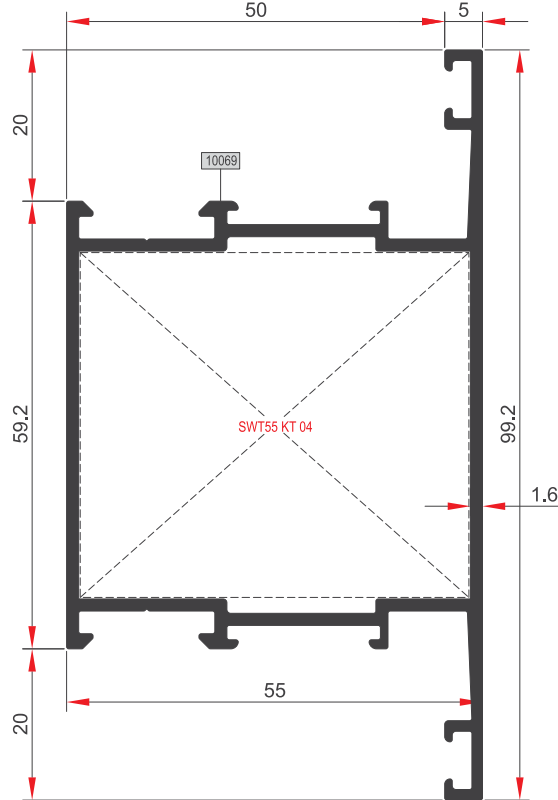

**SW55 KY 03**

AĞIRLIK (kg/m) / WEIGHT kg/m	1.323
Jx (cm <sup>4</sup> )	22.995
Jy (cm <sup>4</sup> )	33.718

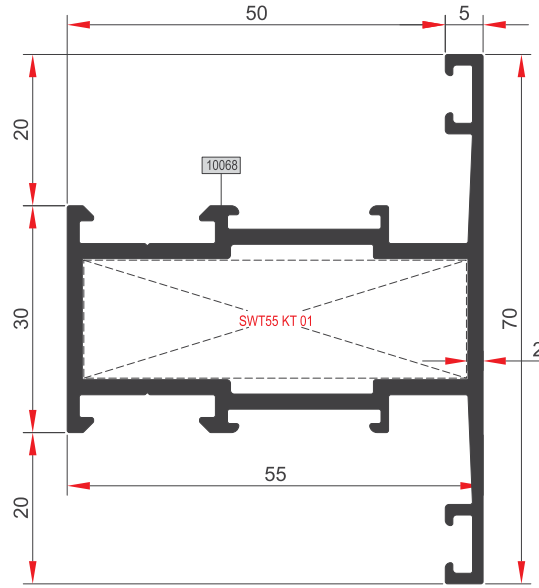

### SW55 KY 02

AĞIRLIK (kg/m) / WEIGHT kg/m	1.225
Jx (cm <sup>4</sup> )	18.048
Jy (cm <sup>4</sup> )	9.708

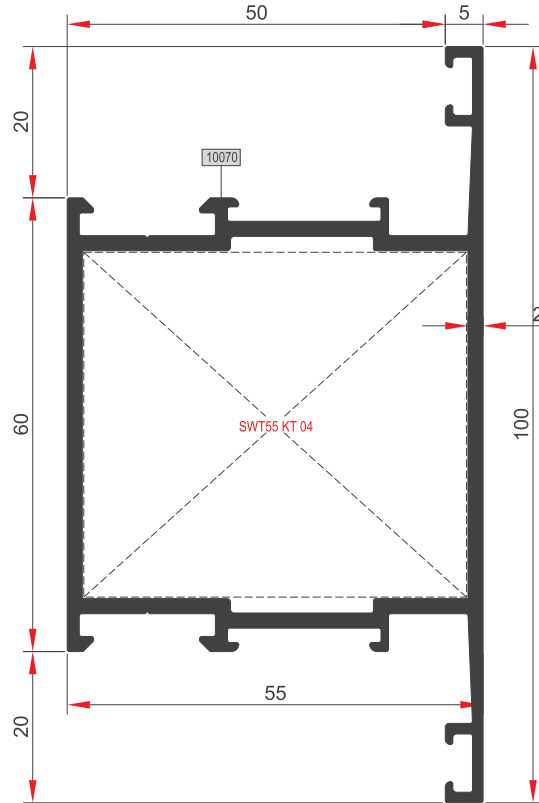

### SW55 KY 03

AĞIRLIK (kg/m) / WEIGHT kg/m	1.549
Jx (cm <sup>4</sup> )	26.700
Jy (cm <sup>4</sup> )	37.860

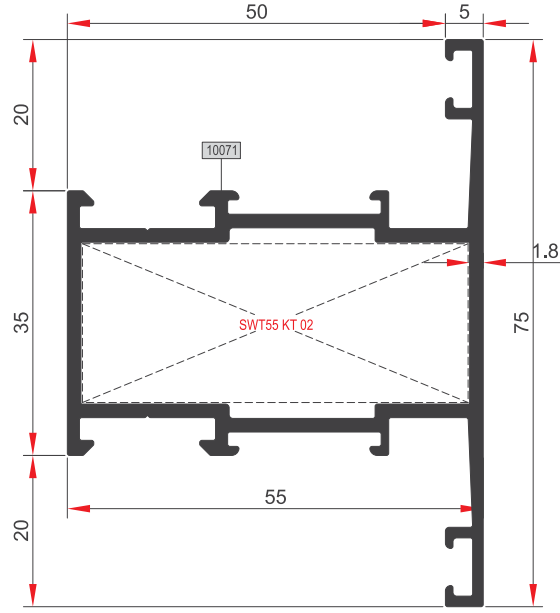

### SW55 KY 05

AĞIRLIK (kg/m) / WEIGHT kg/m	1.197
Jx (cm <sup>4</sup> )	18.415
Jy (cm <sup>4</sup> )	12.521

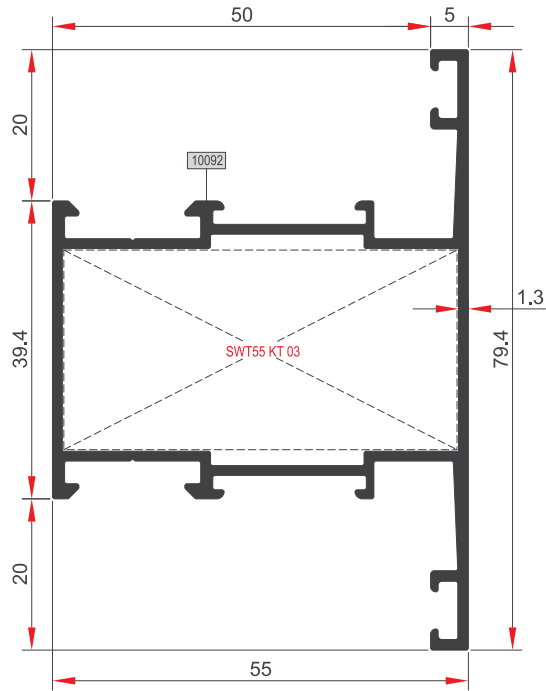

### SW55 KY 07

AĞIRLIK (kg/m) / WEIGHT kg/m	1.018
Jx (cm <sup>4</sup> )	16.384
Jy (cm <sup>4</sup> )	14.386

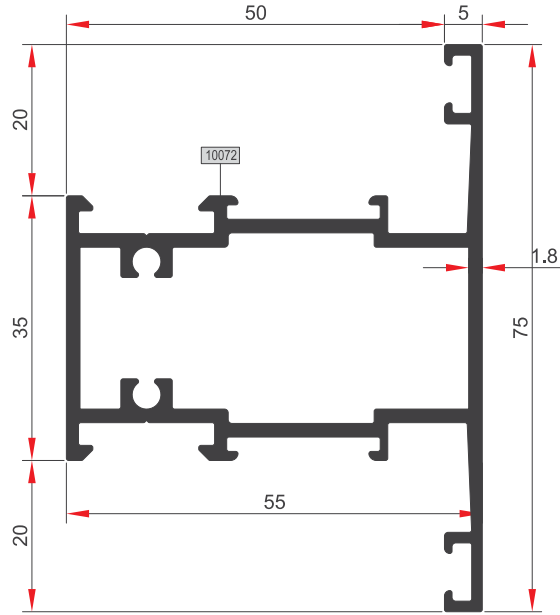

### SW55 KY 06

AĞIRLIK (kg/m) / WEIGHT kg/m	1.279
Jx (cm <sup>4</sup> )	19.785
Jy (cm <sup>4</sup> )	12.756

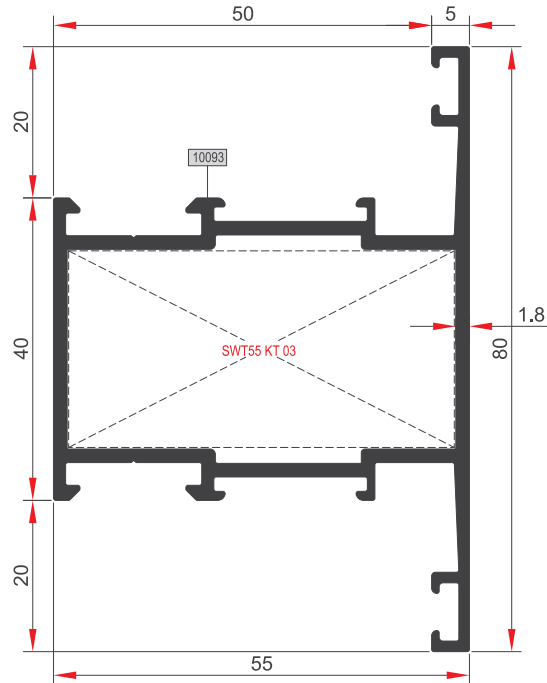

### SW55 KY 08

AĞIRLIK (kg/m) / WEIGHT kg/m	1.245
Jx (cm <sup>4</sup> )	19.728
Jy (cm <sup>4</sup> )	16.069

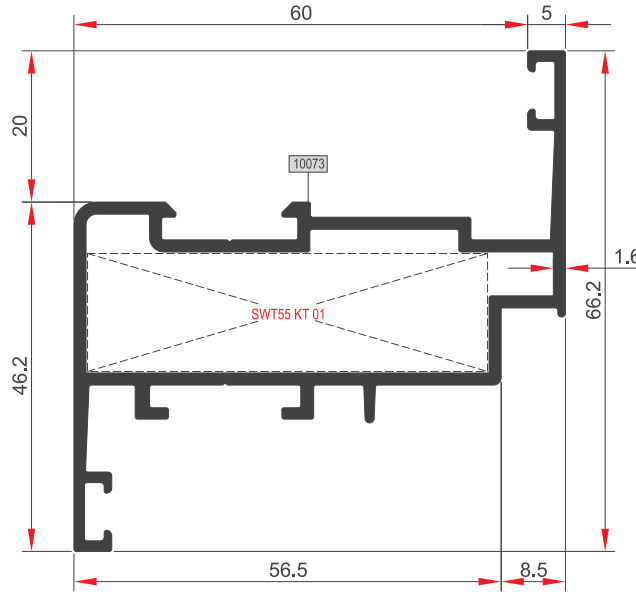

### SW55 KN 01

AĞIRLIK (kg/m) / WEIGHT kg/m	1.141
Jx (cm <sup>4</sup> )	23.308
Jy (cm <sup>4</sup> )	8.383

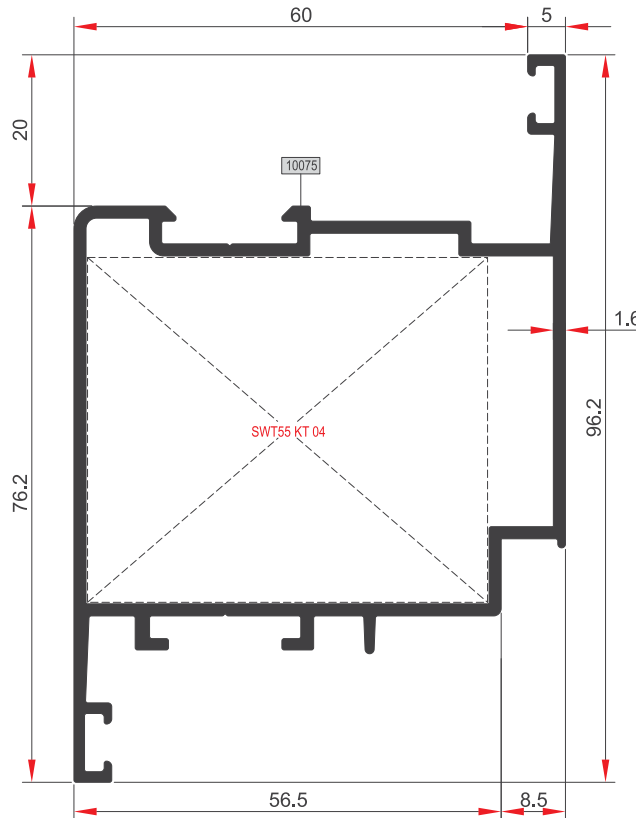

### SW55 KN 03

AĞIRLIK (kg/m) / WEIGHT kg/m	1.401
Jx (cm <sup>4</sup> )	32.972
Jy (cm <sup>4</sup> )	33.794



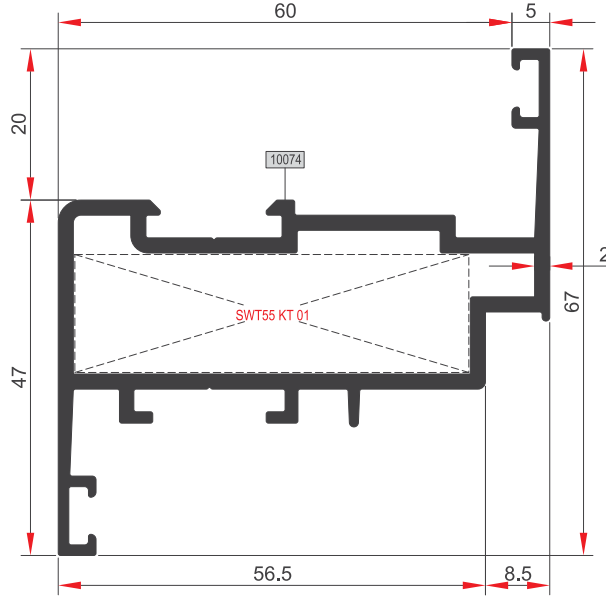

**SW55 KN 02**

AĞIRLIK (kg/m) / WEIGHT kg/m	1.332
Jx (cm <sup>4</sup> )	26.438
Jy (cm <sup>4</sup> )	9.252

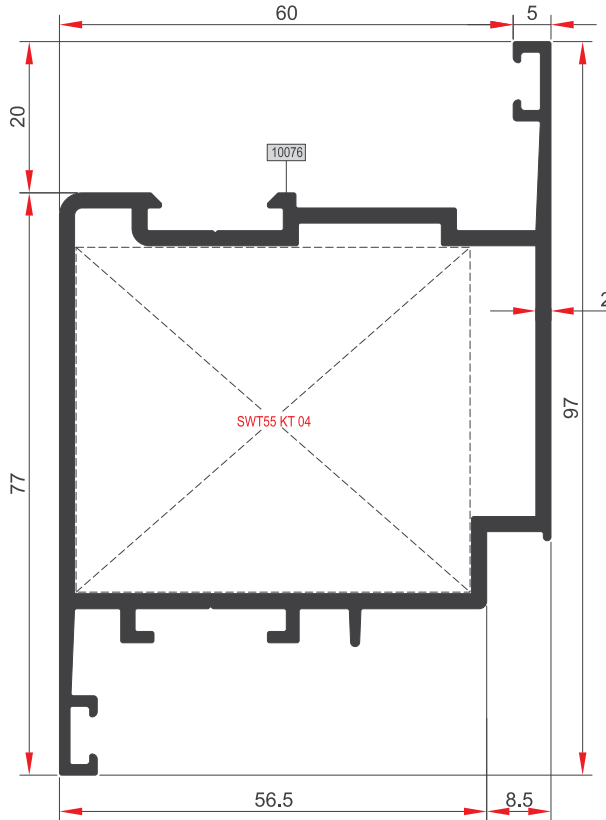

**SW55 KN 04**

AĞIRLIK (kg/m) / WEIGHT kg/m	1.656
Jx (cm <sup>4</sup> )	38.368
Jy (cm <sup>4</sup> )	38.487

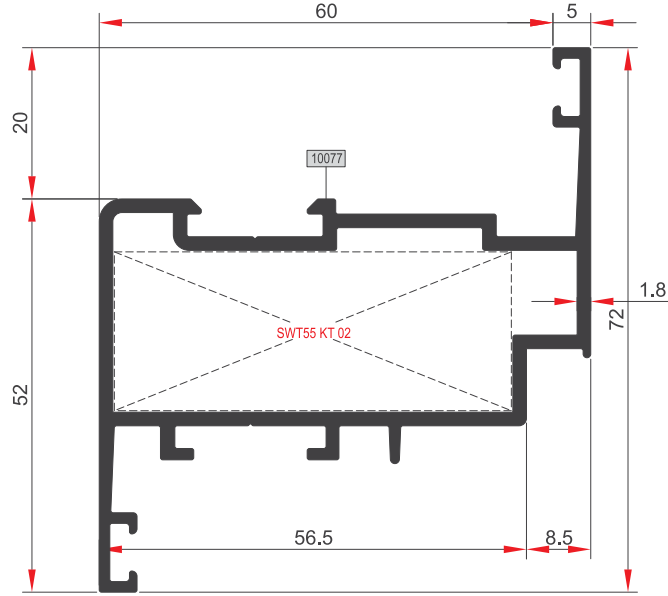

**SW55 KN 05**

AĞIRLIK (kg/m) / WEIGHT kg/m	1.289
Jx (cm <sup>4</sup> )	26.821
Jy (cm <sup>4</sup> )	12.066

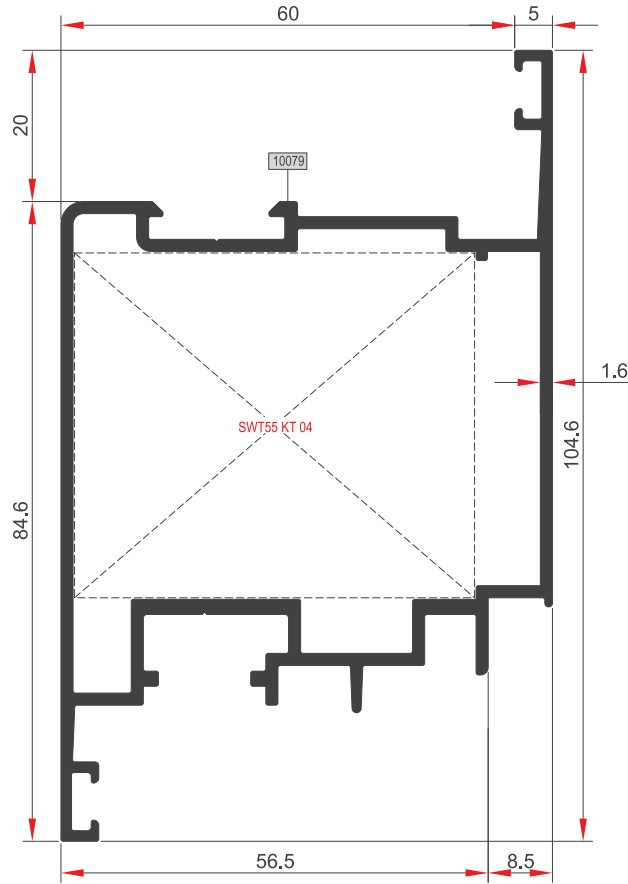

**SW55 KN 07**

AĞIRLIK (kg/m) / WEIGHT kg/m	1.617
Jx (cm <sup>4</sup> )	36.695
Jy (cm <sup>4</sup> )	45.961

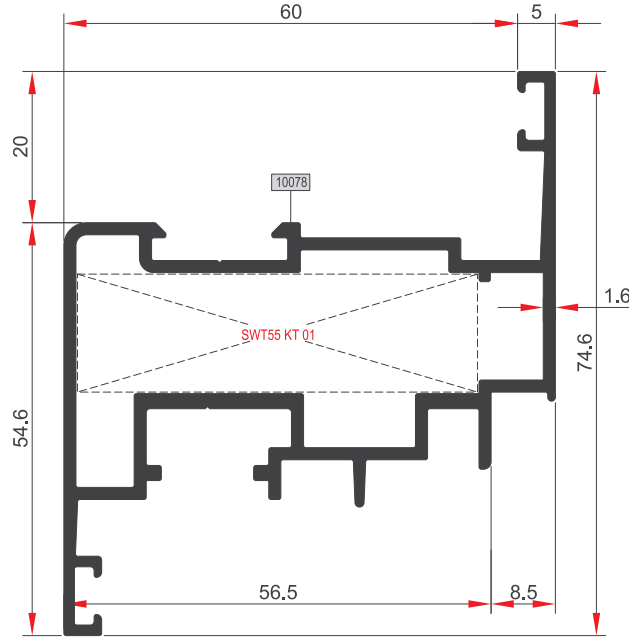

**SW55 KN 06**

AĞIRLIK (kg/m) / WEIGHT kg/m	1.358
Jx (cm <sup>4</sup> )	27.031
Jy (cm <sup>4</sup> )	13.072

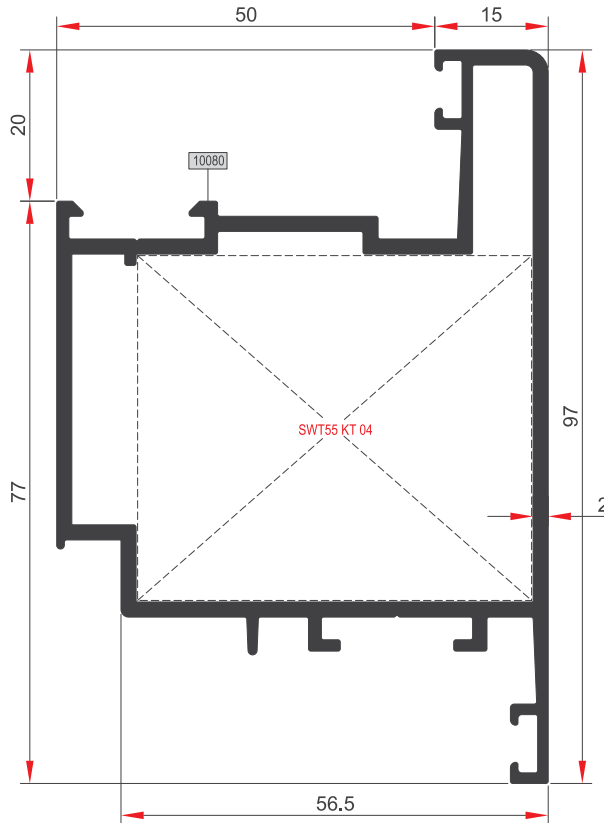

**SW55 KN 08**

AĞIRLIK (kg/m) / WEIGHT kg/m	1.765
Jx (cm <sup>4</sup> )	37.872
Jy (cm <sup>4</sup> )	46.221

# SW55

KANAT PROFİLLERİ  
SASH PROFILES

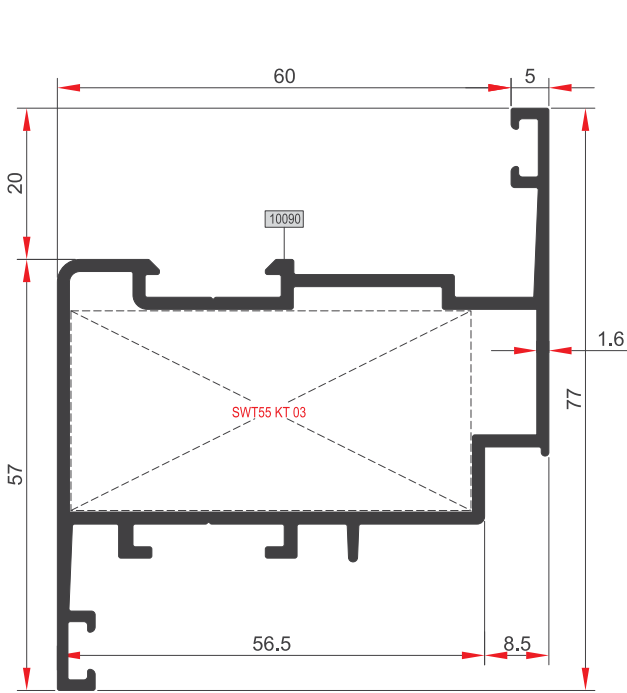

**SW55 KN 09**

AĞIRLIK (kg/m) / WEIGHT kg/m	1.235
Jx (cm <sup>4</sup> )	26.788
Jy (cm <sup>4</sup> )	15.114

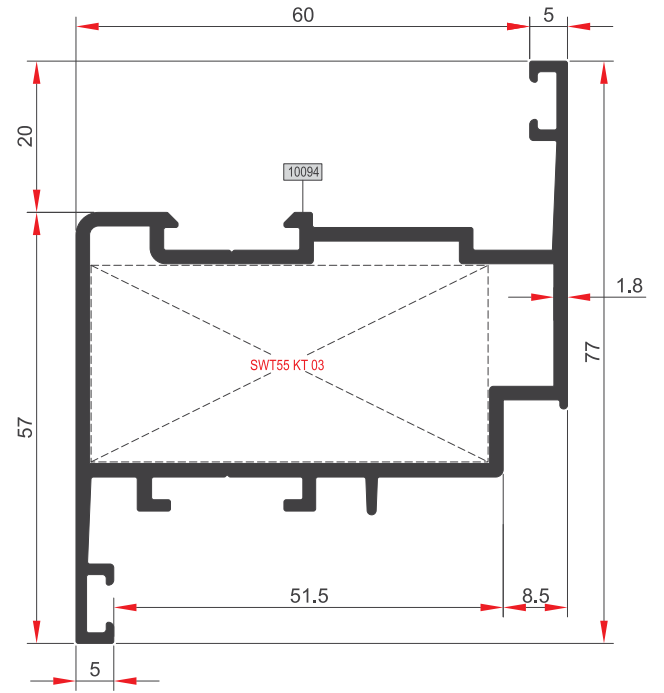

**SW55 KN 10**

AĞIRLIK (kg/m) / WEIGHT kg/m	1.337
Jx (cm <sup>4</sup> )	28.619
Jy (cm <sup>4</sup> )	15.698

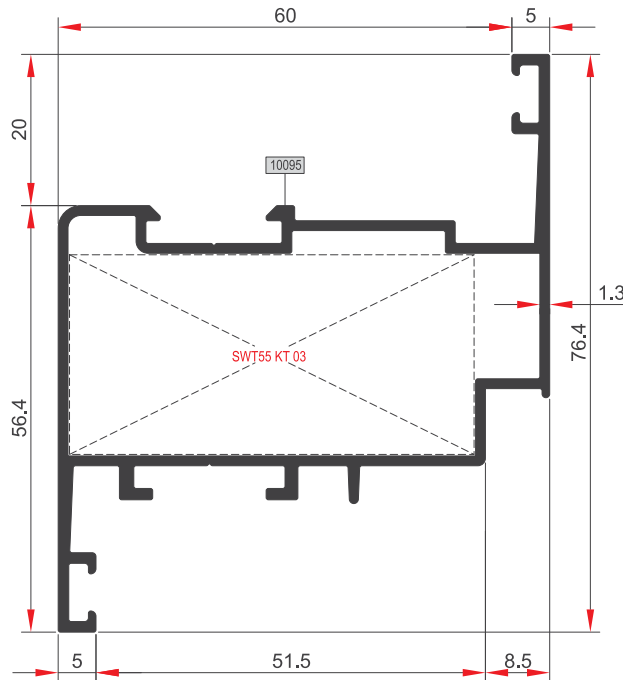

**SW55 KN 11**

AĞIRLIK (kg/m) / WEIGHT kg/m	1.074
Jx (cm <sup>4</sup> )	23.797
Jy (cm <sup>4</sup> )	13.790

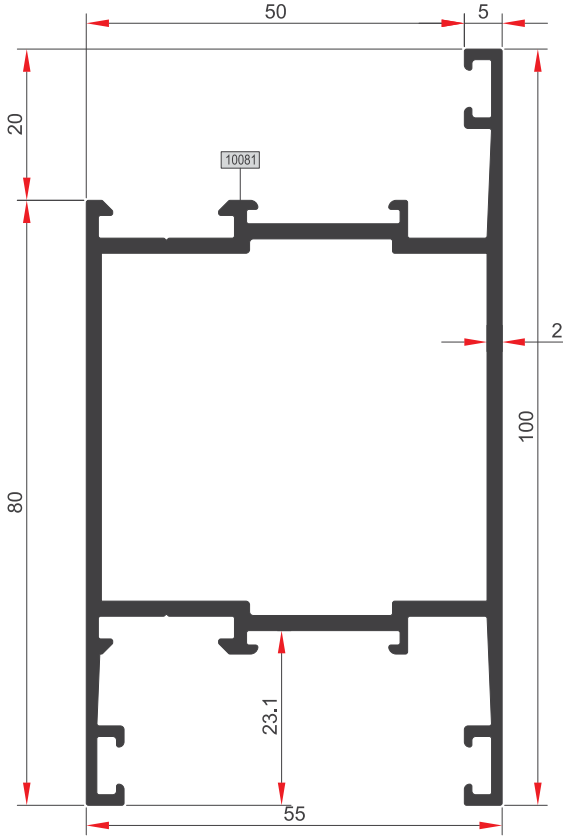

**SW55 KE 01**

AĞIRLIK (kg/m) / WEIGHT kg/m	1.664
Jx (cm <sup>4</sup> )	30.220
Jy (cm <sup>4</sup> )	44.712

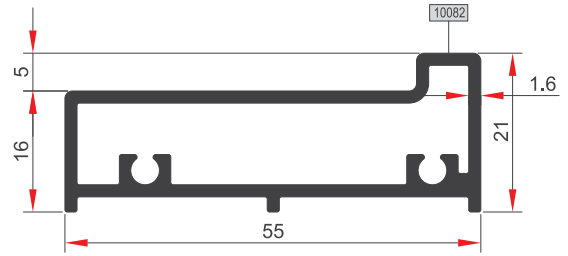

**SW55 KE 02**

AĞIRLIK (kg/m) / WEIGHT kg/m	0.720
Jx (cm <sup>4</sup> )	9.335
Jy (cm <sup>4</sup> )	1.031

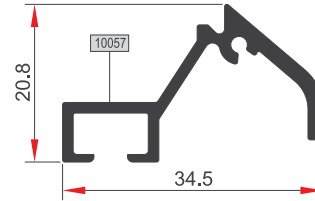

**SW55 KW 03**

AĞIRLIK (kg/m) / WEIGHT kg/m	0.315
Jx (cm <sup>4</sup> )	1.306
Jy (cm <sup>4</sup> )	0.346

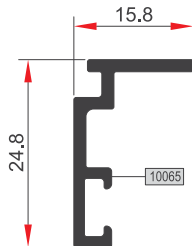

**SW55 AD 05**

AĞIRLIK (kg/m) / WEIGHT kg/m	0.205
Jx (cm <sup>4</sup> )	0.122
Jy (cm <sup>4</sup> )	0.523

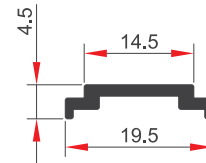

**SW55 T 01**

AĞIRLIK (kg/m) / WEIGHT kg/m	0.105
Jx (cm <sup>4</sup> )	0.144
Jy (cm <sup>4</sup> )	0.005

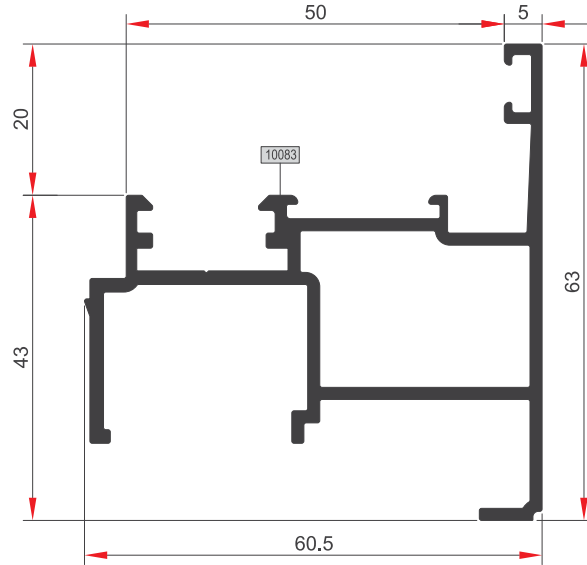

### SW55 AD 01

AĞIRLIK (kg/m) / WEIGHT kg/m	1.091
Jx (cm <sup>4</sup> )	17.465
Jy (cm <sup>4</sup> )	7.685

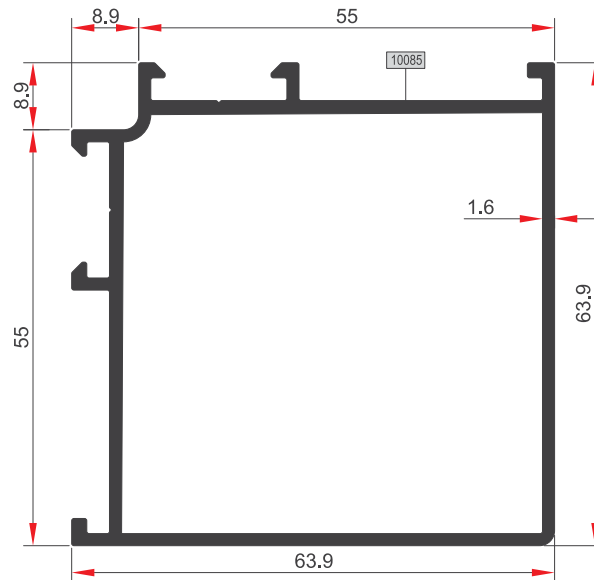

### SW55 AD 03

AĞIRLIK (kg/m) / WEIGHT kg/m	1.165
Jx (cm <sup>4</sup> )	24.657
Jy (cm <sup>4</sup> )	24.657

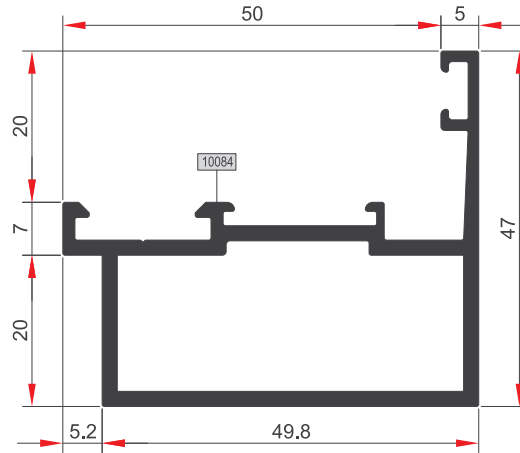

### SW55 AD 02

AĞIRLIK (kg/m) / WEIGHT kg/m	0.989
Jx (cm <sup>4</sup> )	12.941
Jy (cm <sup>4</sup> )	5.544

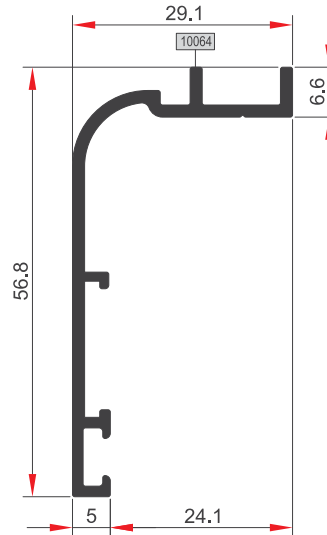

### SW55 AD 04

AĞIRLIK (kg/m) / WEIGHT kg/m	0.429
Jx (cm <sup>4</sup> )	1.330
Jy (cm <sup>4</sup> )	5.343



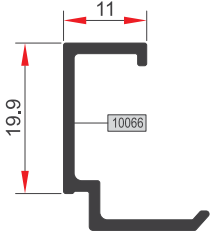

**SW55 C 01**

AĞIRLIK (kg/m) / WEIGHT kg/m	0,205
Jx (cm <sup>4</sup> )	0,206
Jy (cm <sup>4</sup> )	0,666

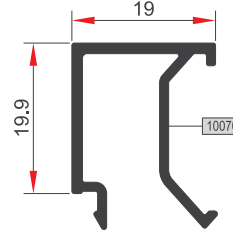

**SW55 C 05**

AĞIRLIK (kg/m) / WEIGHT kg/m	0,261
Jx (cm <sup>4</sup> )	0,383
Jy (cm <sup>4</sup> )	0,638

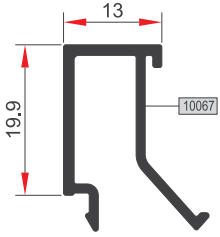

**SW55 C 02**

AĞIRLIK (kg/m) / WEIGHT kg/m	0,237
Jx (cm <sup>4</sup> )	0,261
Jy (cm <sup>4</sup> )	0,558

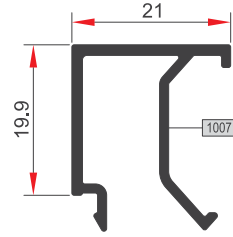

**SW55 C 06**

AĞIRLIK (kg/m) / WEIGHT kg/m	0,269
Jx (cm <sup>4</sup> )	0,429
Jy (cm <sup>4</sup> )	0,660

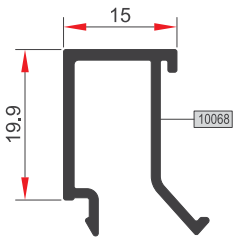

**SW55 C 03**

AĞIRLIK (kg/m) / WEIGHT kg/m	0,242
Jx (cm <sup>4</sup> )	0,309
Jy (cm <sup>4</sup> )	0,582

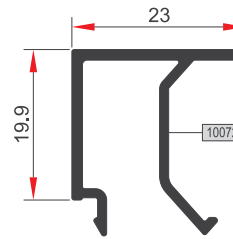

**SW55 C 07**

AĞIRLIK (kg/m) / WEIGHT kg/m	0,277
Jx (cm <sup>4</sup> )	0,488
Jy (cm <sup>4</sup> )	0,681

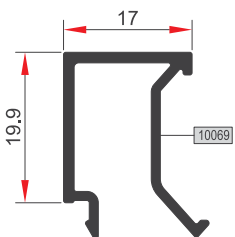

**SW55 C 04**

AĞIRLIK (kg/m) / WEIGHT kg/m	0,254
Jx (cm <sup>4</sup> )	0,348
Jy (cm <sup>4</sup> )	0,615

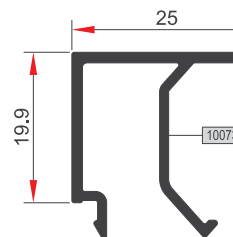

**SW55 C 08**

AĞIRLIK (kg/m) / WEIGHT kg/m	0,284
Jx (cm <sup>4</sup> )	0,561
Jy (cm <sup>4</sup> )	0,701

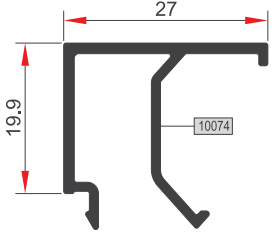

SWT55 C 09	
AĞIRLIK (kg/m) / WEIGHT kg/m	0,292
Jx (cm <sup>4</sup> )	0,648
Jy (cm <sup>4</sup> )	0,719

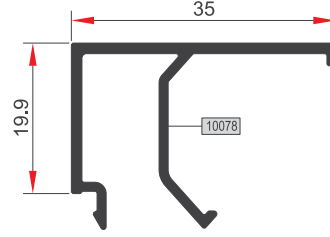

SWT55 C 13	
AĞIRLIK (kg/m) / WEIGHT kg/m	0,322
Jx (cm <sup>4</sup> )	1,064
Jy (cm <sup>4</sup> )	0,786

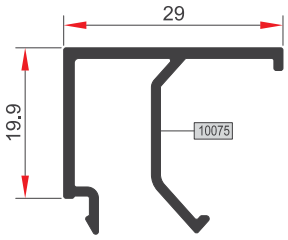

SWT55 C 10	
AĞIRLIK (kg/m) / WEIGHT kg/m	0,299
Jx (cm <sup>4</sup> )	0,751
Jy (cm <sup>4</sup> )	0,737

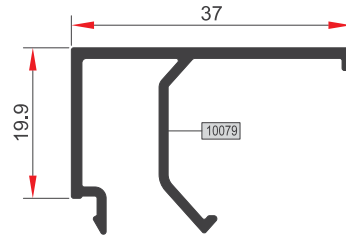

SWT55 C 14	
AĞIRLIK (kg/m) / WEIGHT kg/m	0,329
Jx (cm <sup>4</sup> )	1,340
Jy (cm <sup>4</sup> )	0,801

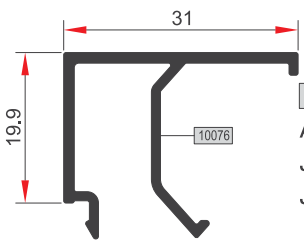

SWT55 C 11	
AĞIRLIK (kg/m) / WEIGHT kg/m	0,307
Jx (cm <sup>4</sup> )	0,871
Jy (cm <sup>4</sup> )	0,754

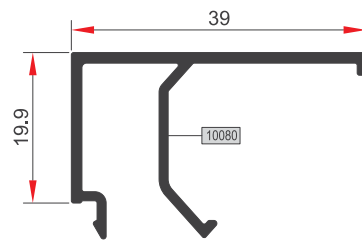

SWT55 C 14	
AĞIRLIK (kg/m) / WEIGHT kg/m	0,304
Jx (cm <sup>4</sup> )	1,536
Jy (cm <sup>4</sup> )	0,815

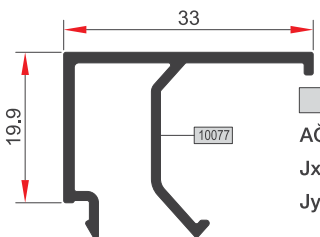

SWT55 C 12	
AĞIRLIK (kg/m) / WEIGHT kg/m	0,314
Jx (cm <sup>4</sup> )	1,008
Jy (cm <sup>4</sup> )	0,770



CAM TABLOSU - Glazing Table

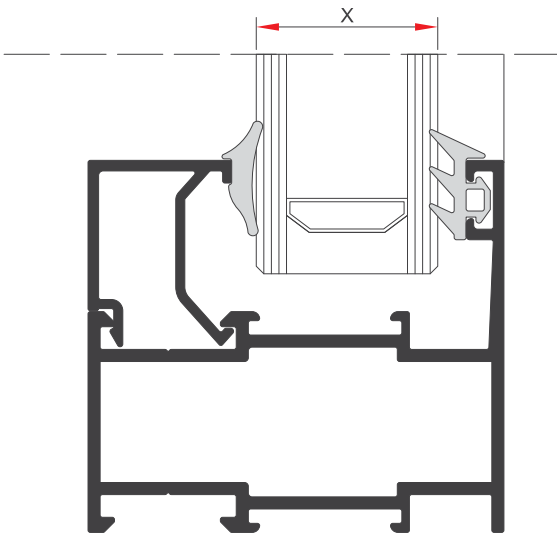

		
	FITIL004	FITIL005
SWT55 C 01	32 mm	31 mm
SWT55 C 02	30 mm	29 mm
SWT55 C 03	28 mm	27 mm
SWT55 C 04	26 mm	25 mm
SWT55 C 05	24 mm	23 mm
SWT55 C 06	22 mm	21 mm
SWT55 C 07	20 mm	19 mm
SWT55 C 08	18 mm	17 mm
SWT55 C 09	16 mm	15 mm
SWT55 C 10	14 mm	13 mm
SWT55 C 11	12 mm	11 mm
SWT55 C 12	10 mm	9 mm
SWT55 C 13	8 mm	7 mm
SWT55 C 14	6 mm	5 mm
SWT55 C 15	4 mm	3 mm

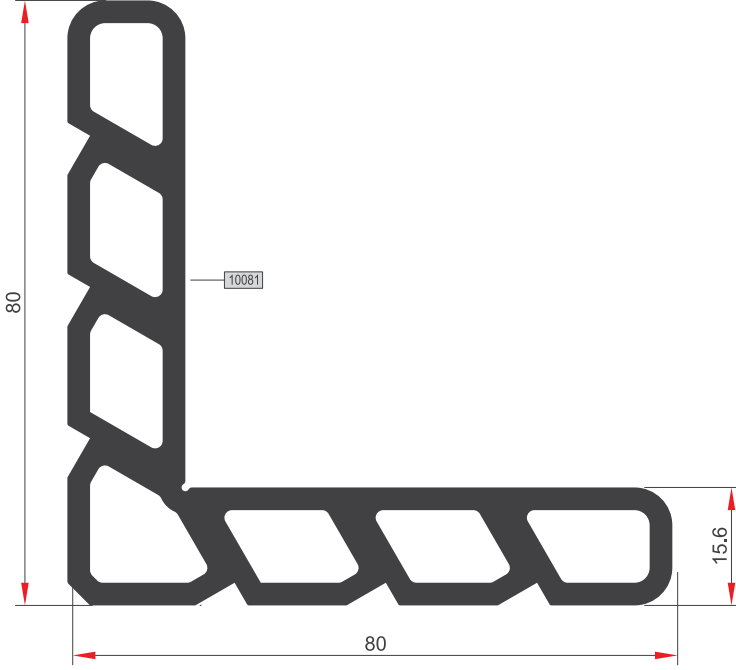
**SW55 KT 01**

AĞIRLIK (kg/m) / WEIGHT kg/m	3,226
Jx (cm <sup>4</sup> )	66,802
Jy (cm <sup>4</sup> )	66,802

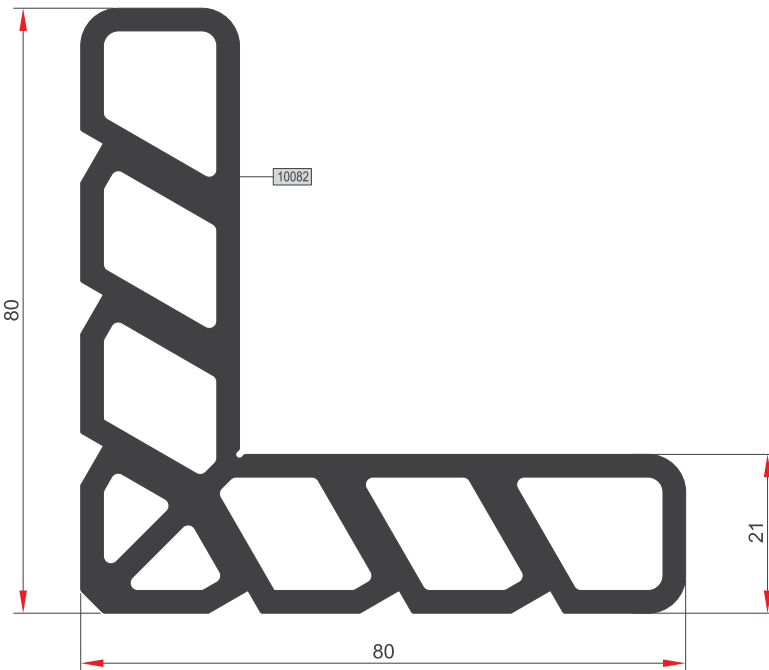
**SW55 KT 02**

AĞIRLIK (kg/m) / WEIGHT kg/m	3,788
Jx (cm <sup>4</sup> )	74,787
Jy (cm <sup>4</sup> )	74,787

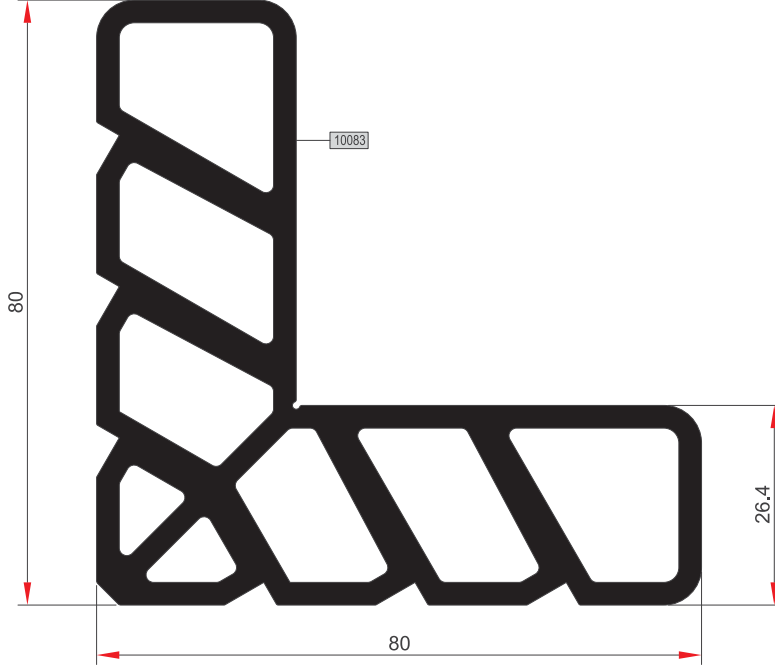

### SW55 KT 03

AĞIRLIK (kg/m) / WEIGHT kg/m	4,109
Jx (cm <sup>4</sup> )	79,786
Jy (cm <sup>4</sup> )	79,786

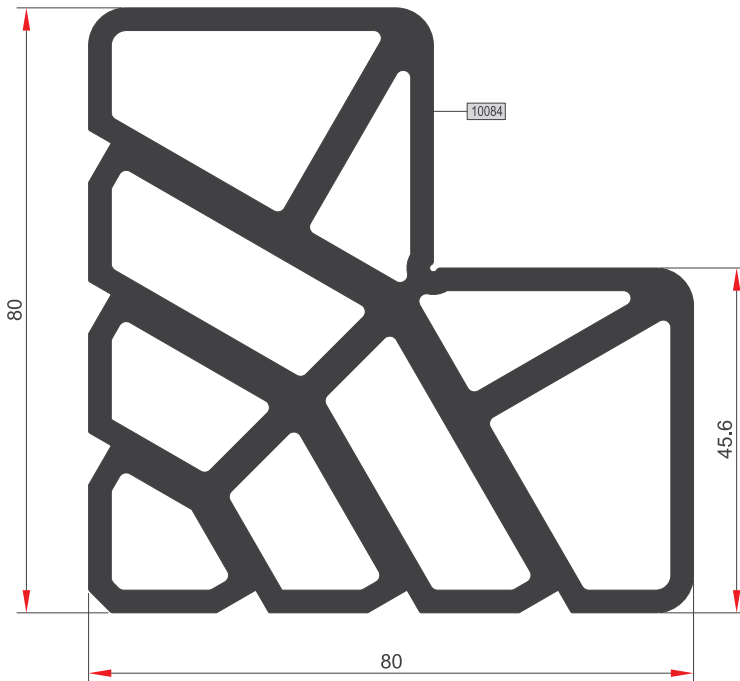

### SW55 KT 04

AĞIRLIK (kg/m) / WEIGHT kg/m	5,602
Jx (cm <sup>4</sup> )	107,561
Jy (cm <sup>4</sup> )	107,561

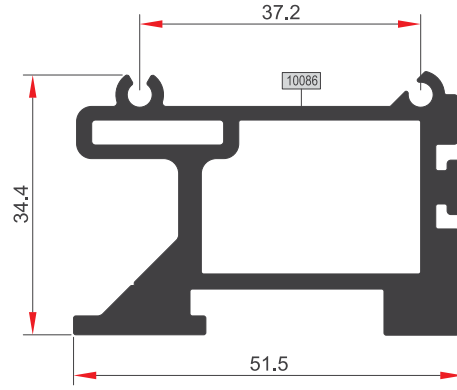

### SW55 KB 01

AĞIRLIK (kg/m) / WEIGHT kg/m	1.460
Jx (cm <sup>4</sup> )	15.578
Jy (cm <sup>4</sup> )	6.337

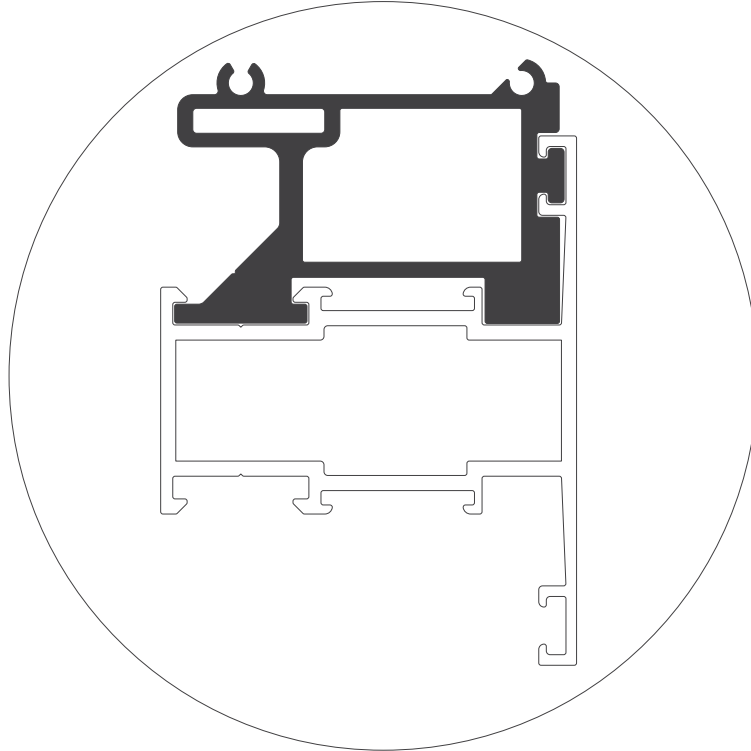

# MİMARİ KATALOG

## ARCHITECTURAL CATALOGUE

Aluminyum Kapı Pencere ve Giydirme Cephe Sistemleri  
Aluminium Window Doors and Facade Systems



ALUSYSTEMS  
Profil Detayları

ALUSYSTEMS  
Profile Details

# SW55

**DETAYLAR**  
DETAILS



# ALUSYSTEMS

Aluminyum Kapı Pencere ve Giydirme Cephe Sistemleri  
Aluminium Window Doors and Facade Systems



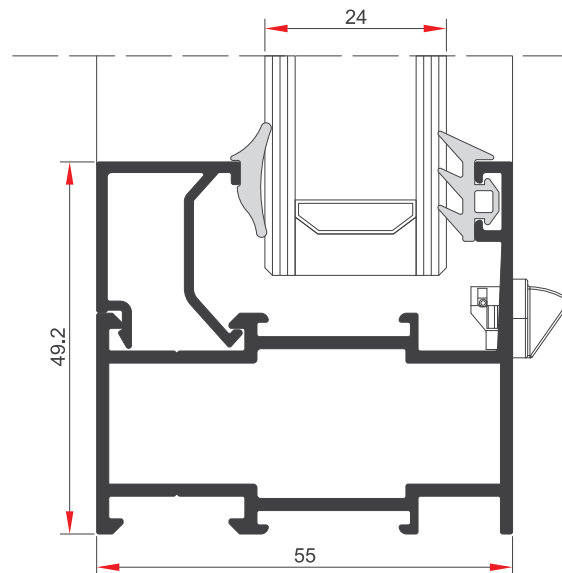
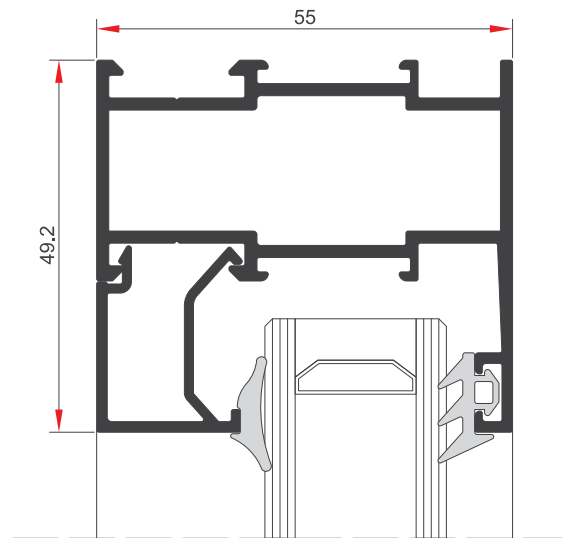
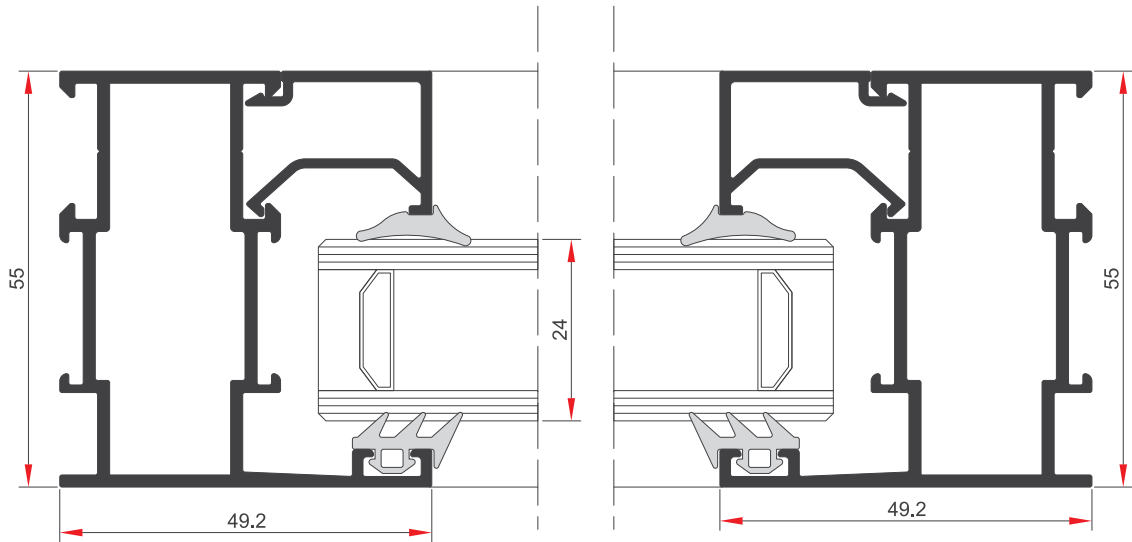

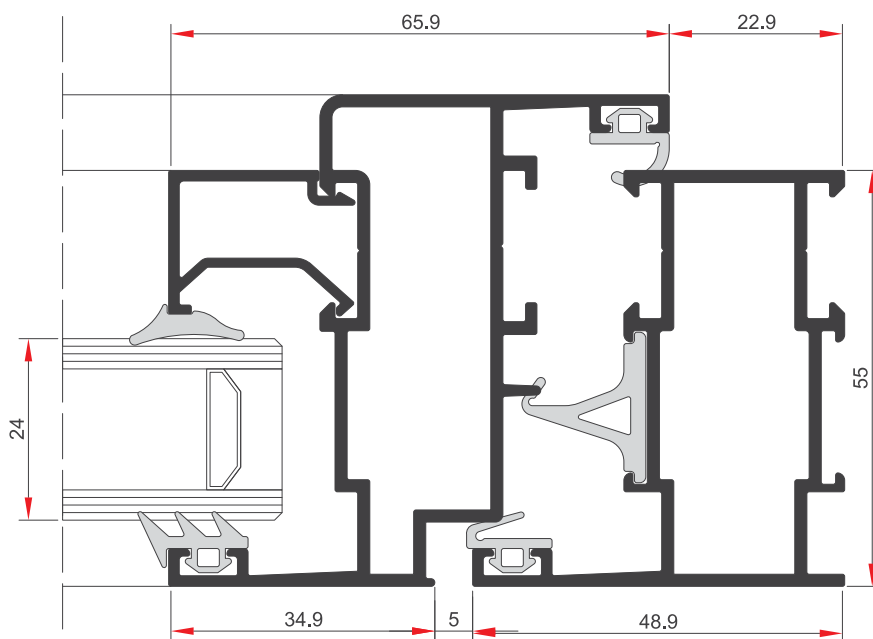
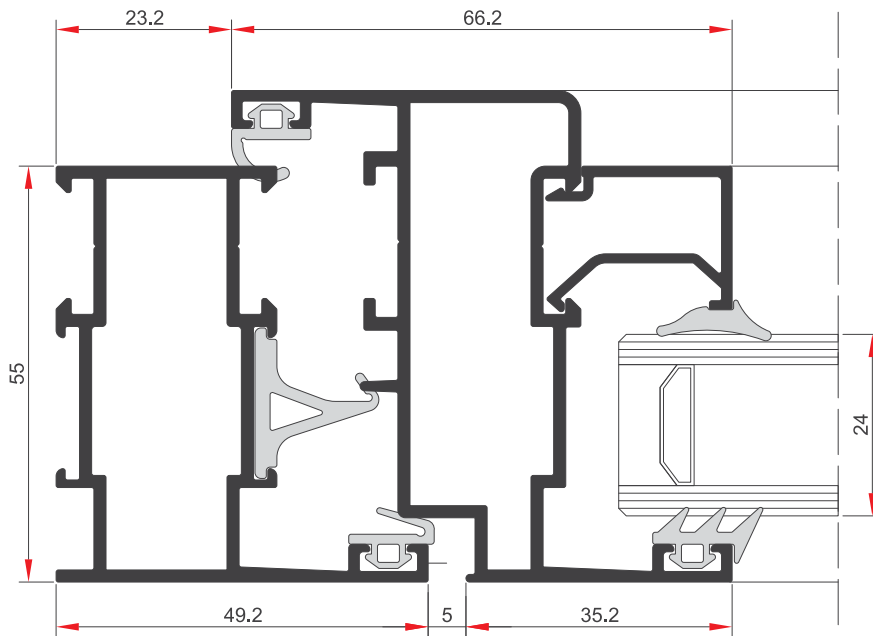

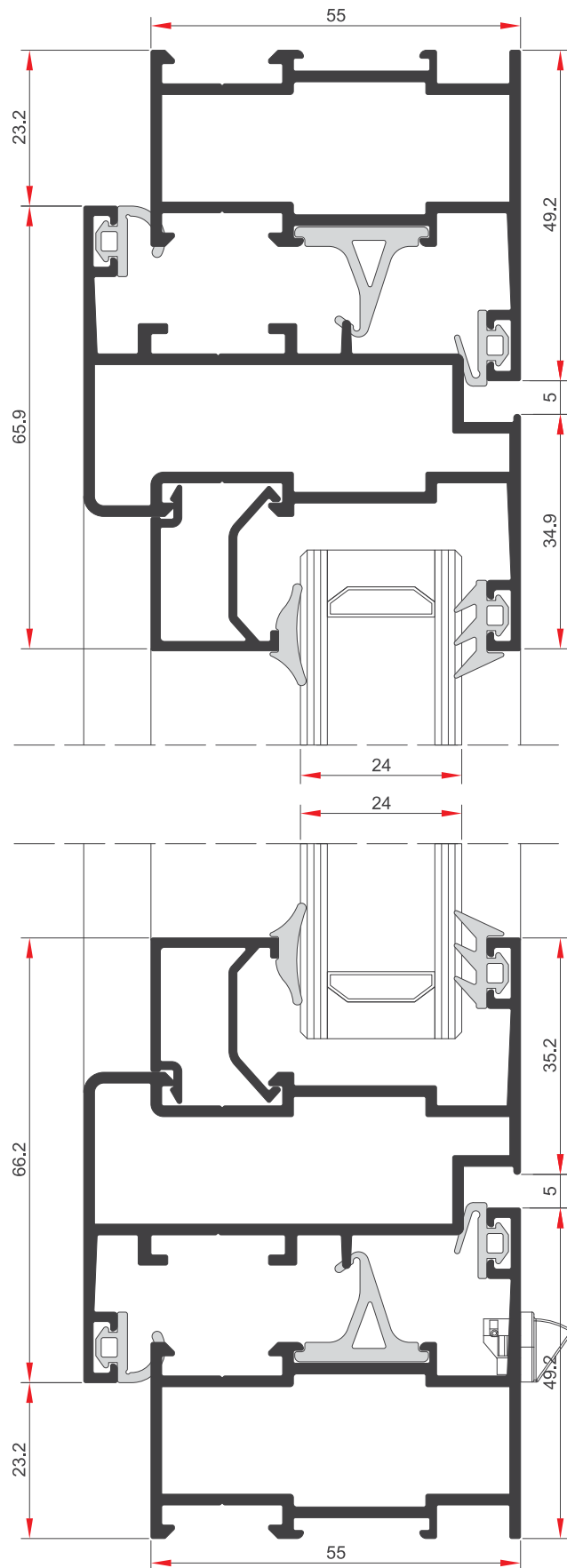

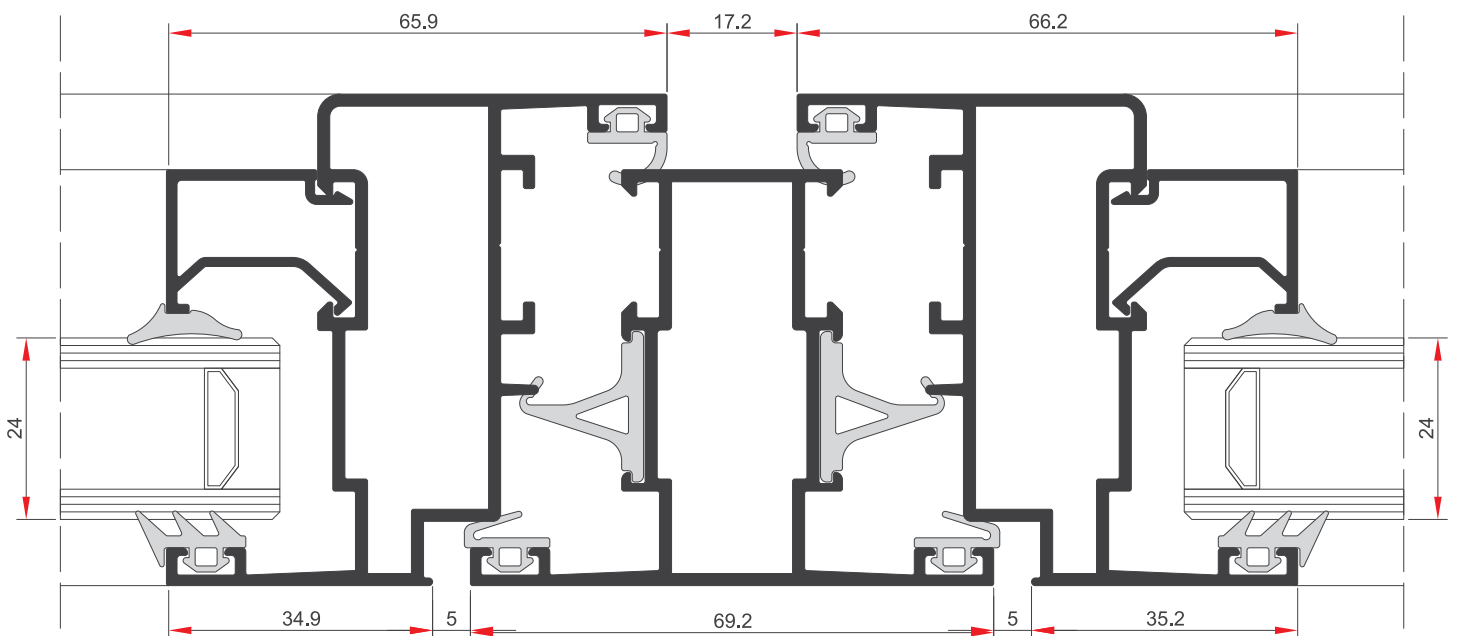
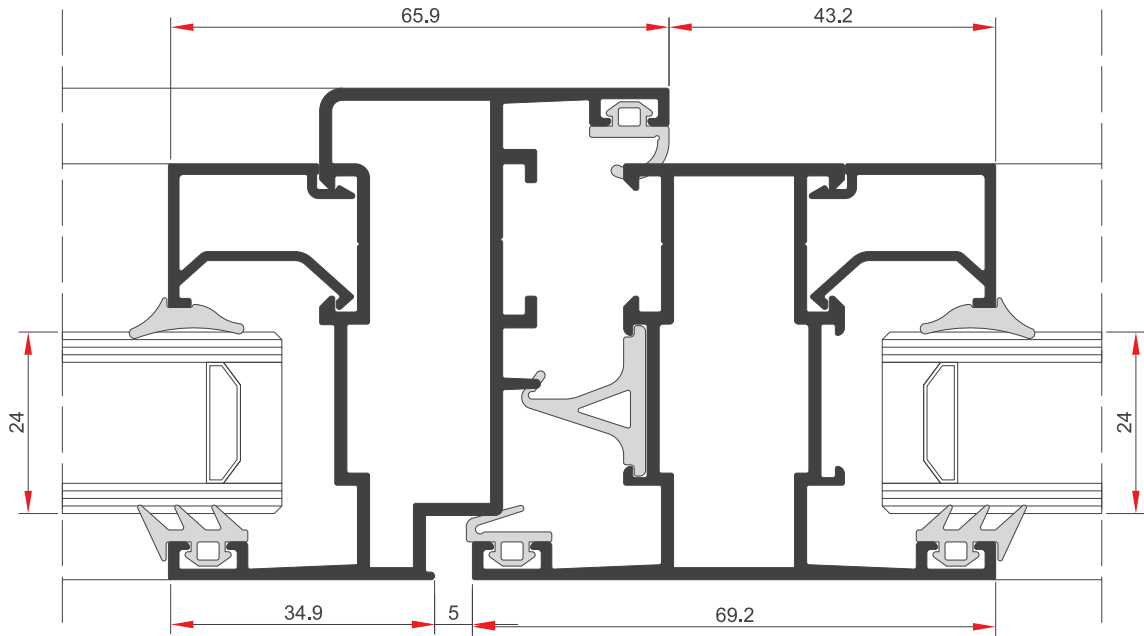

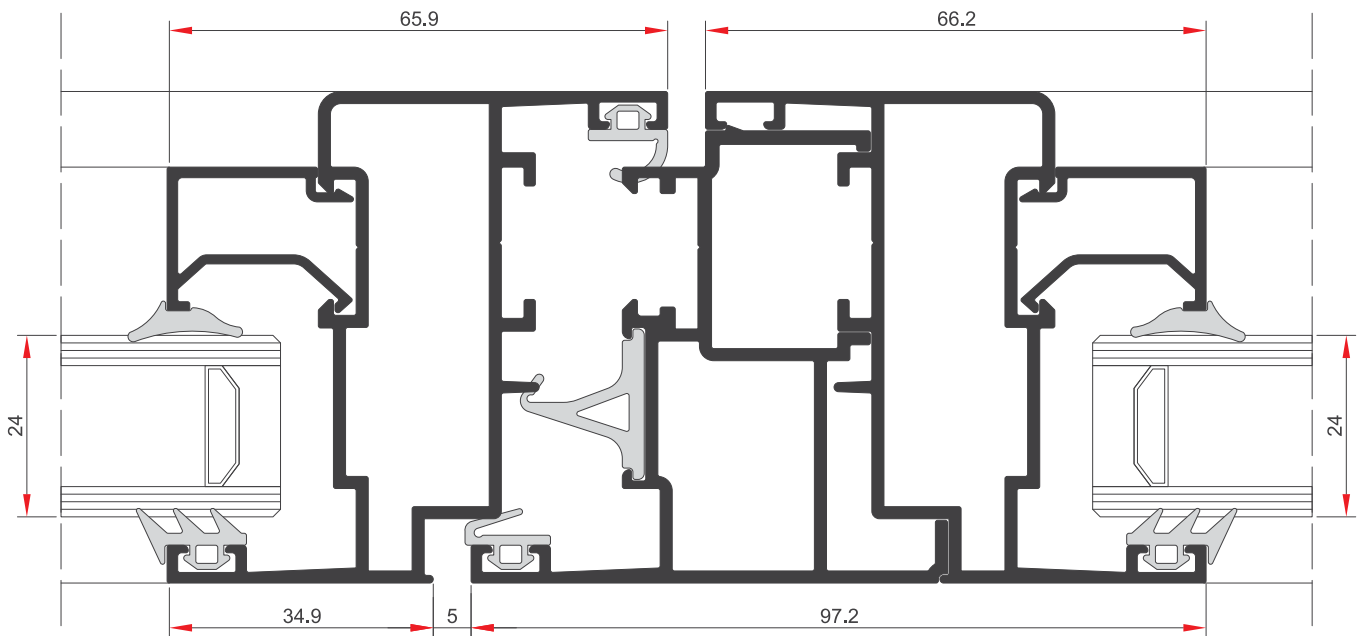

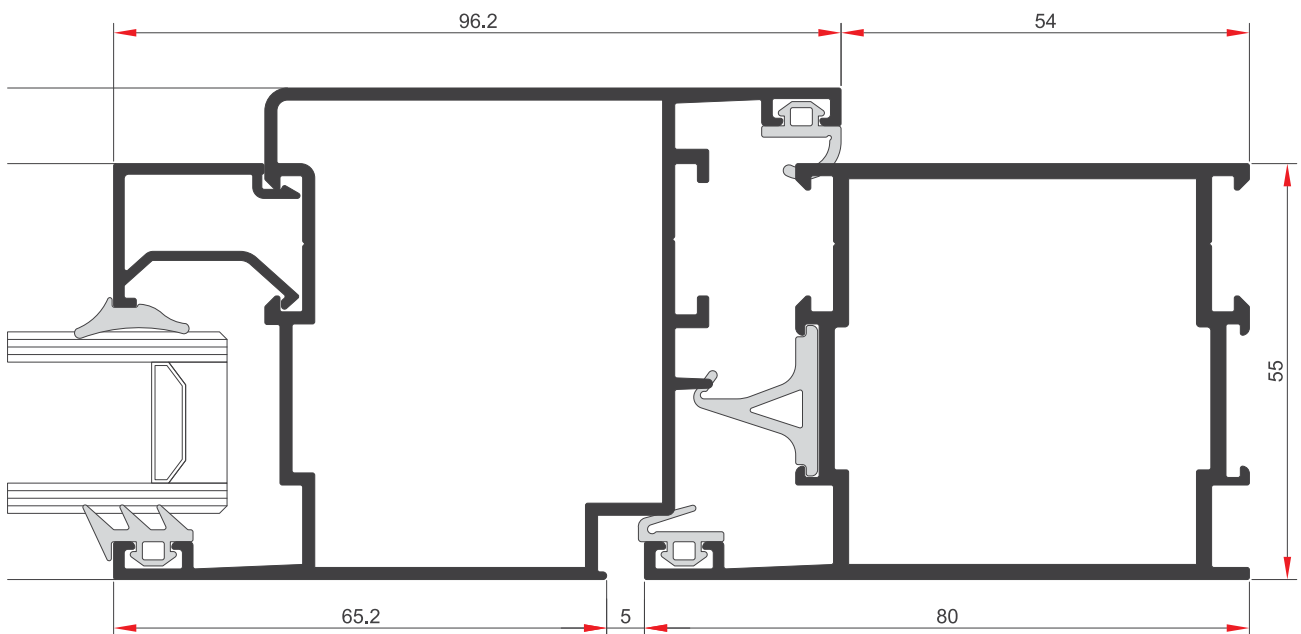
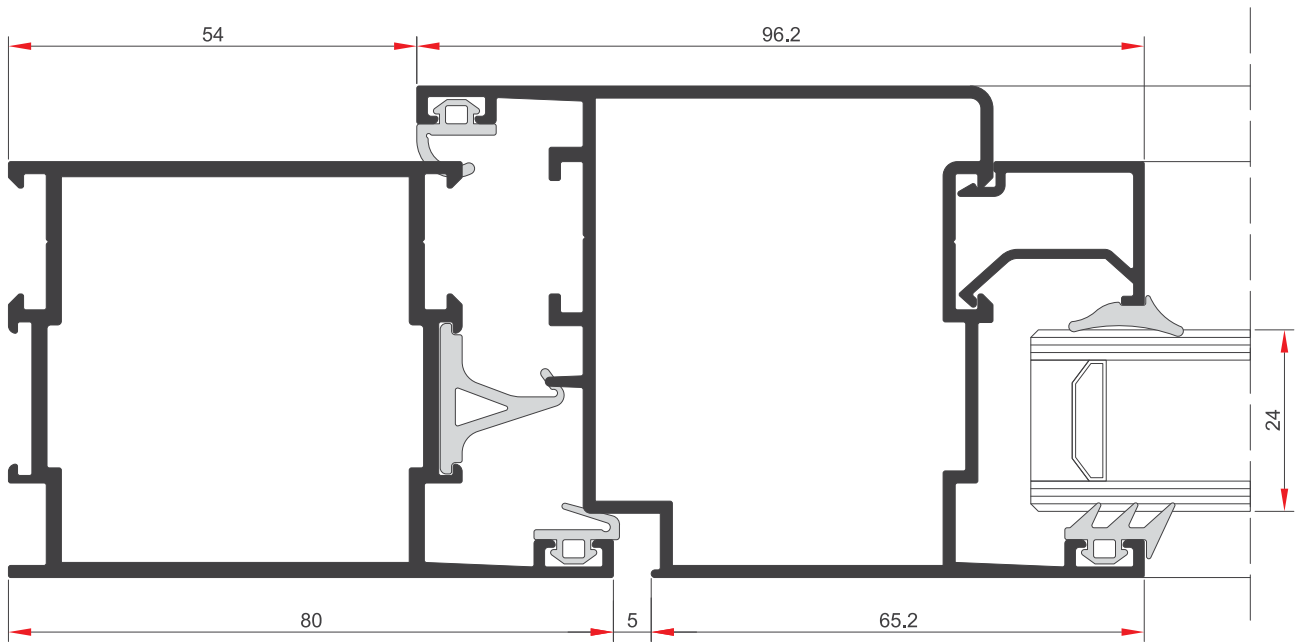

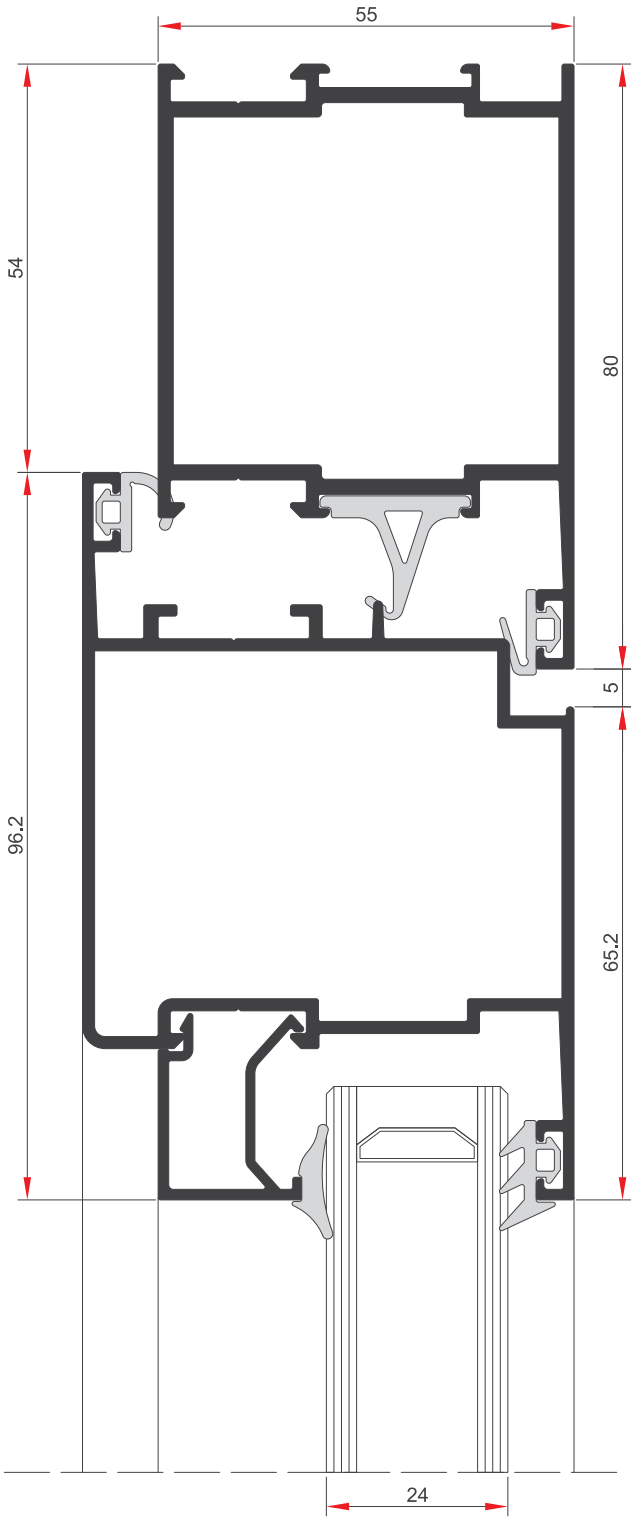



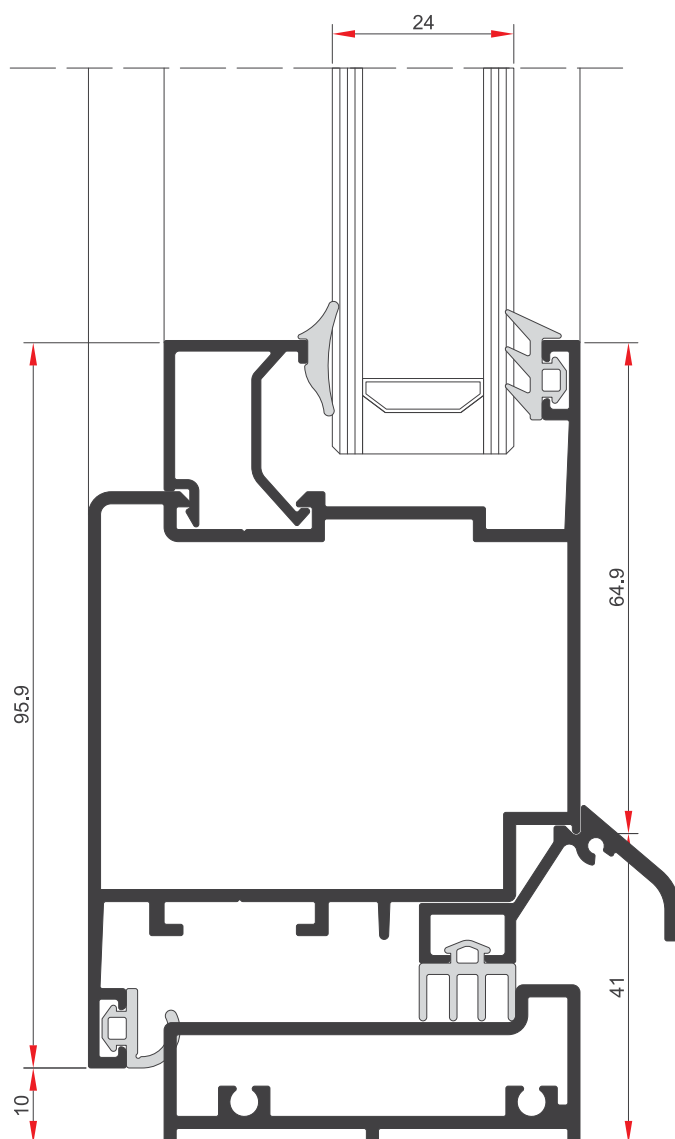

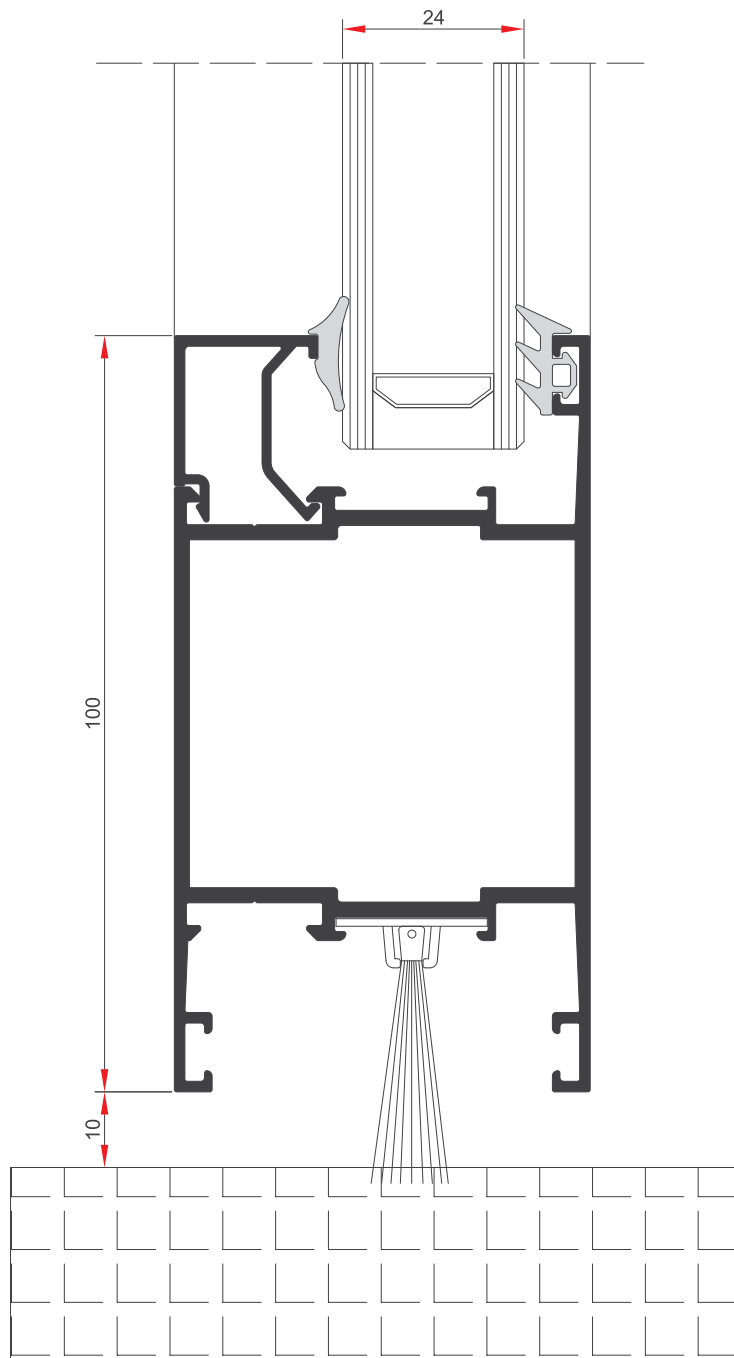

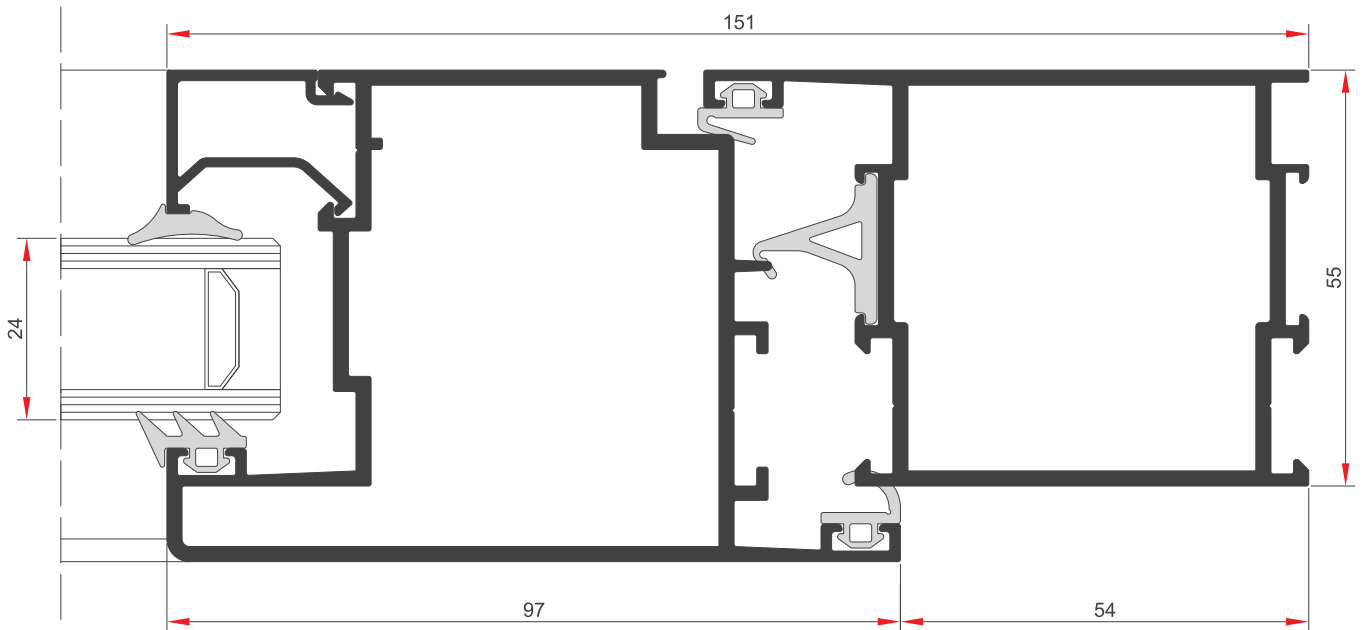
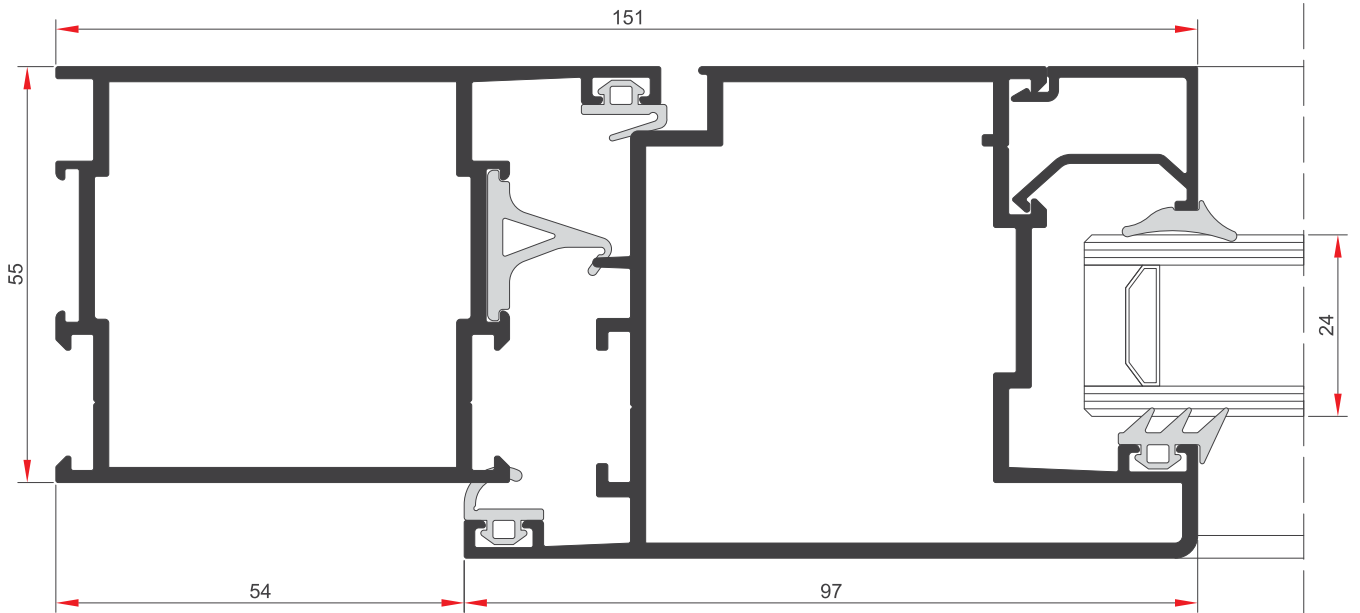

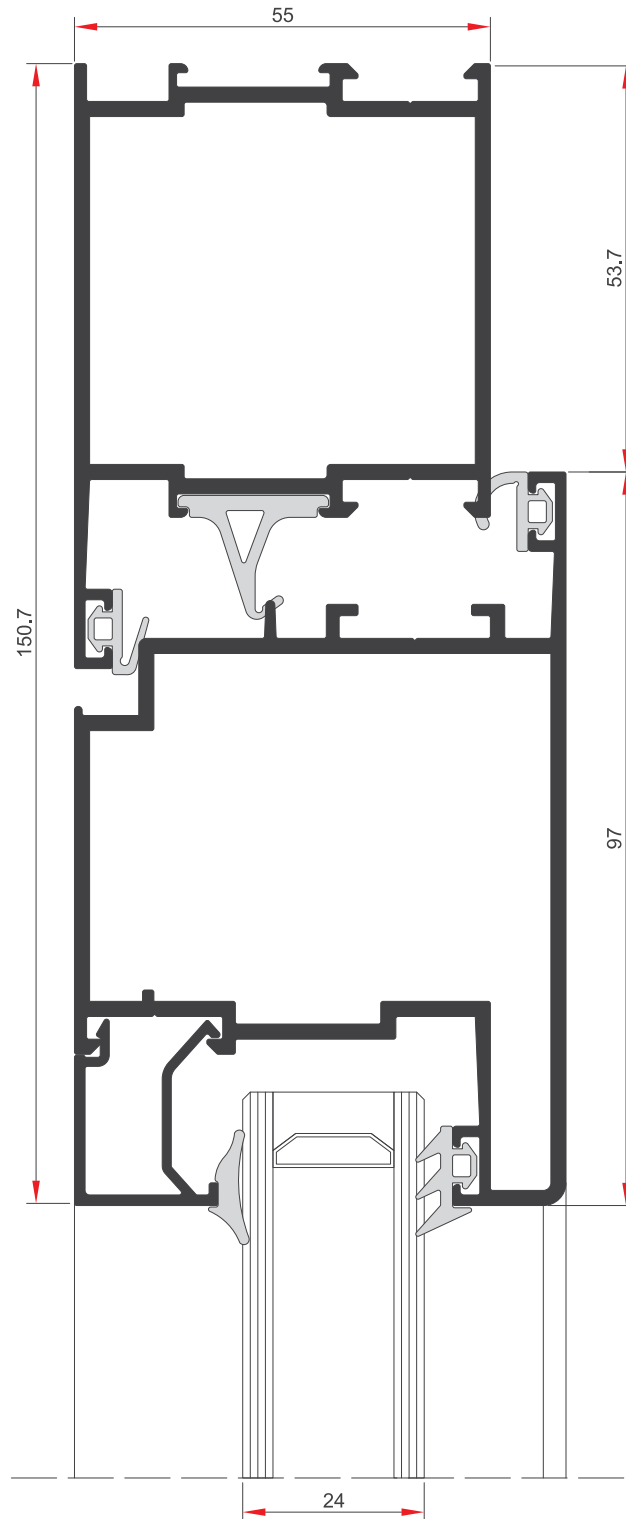

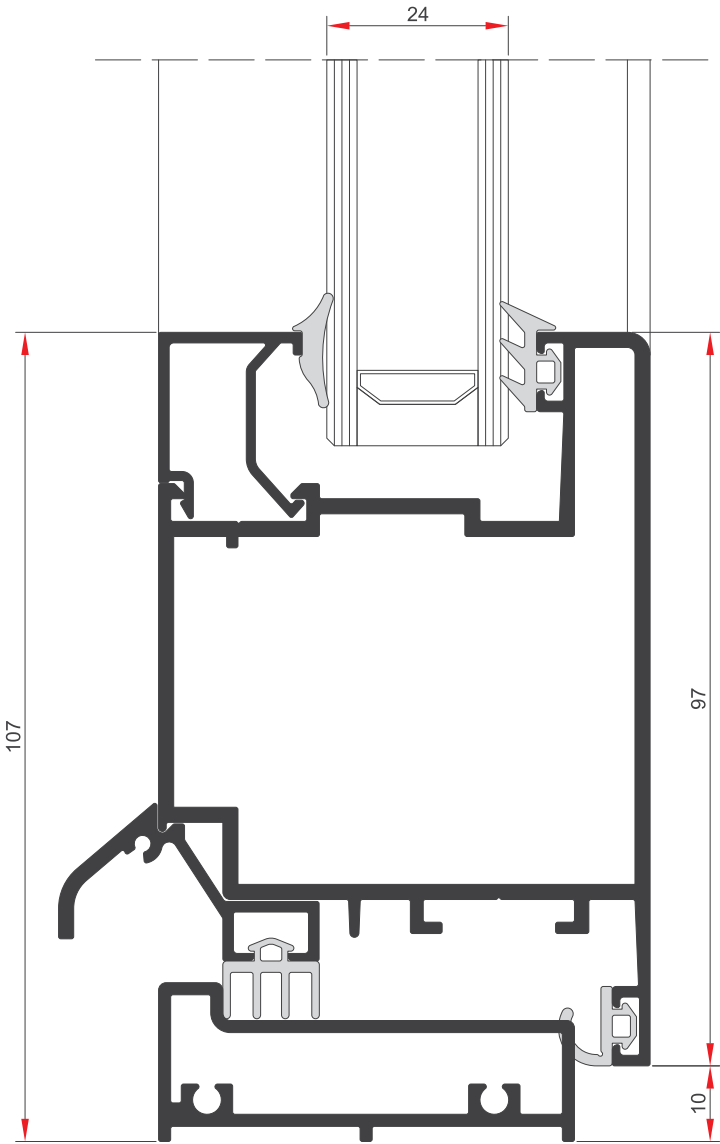

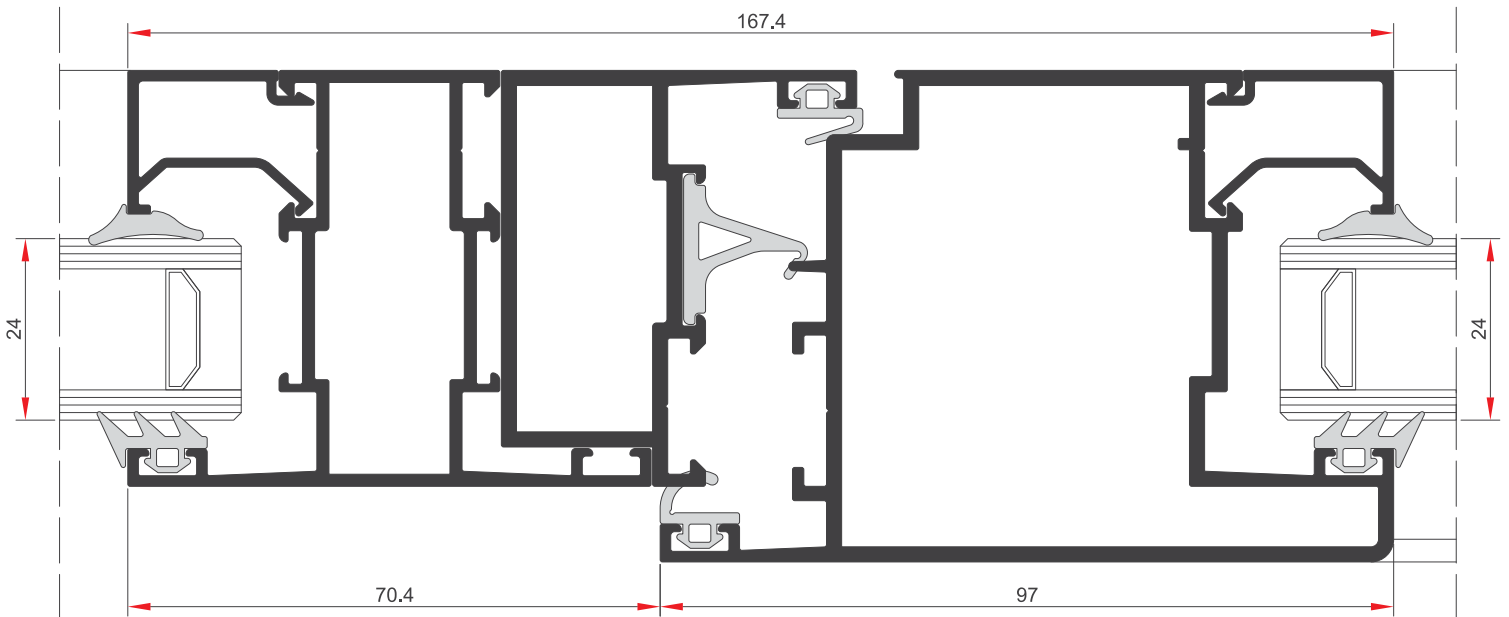
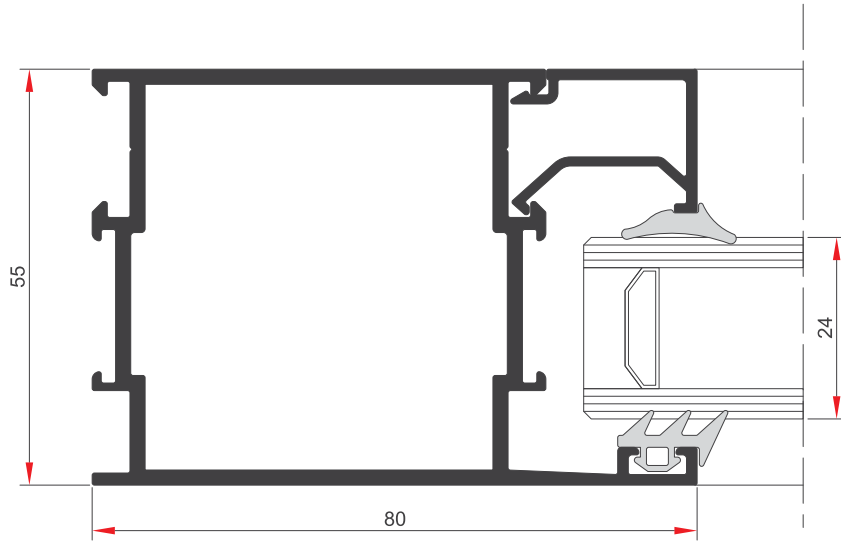

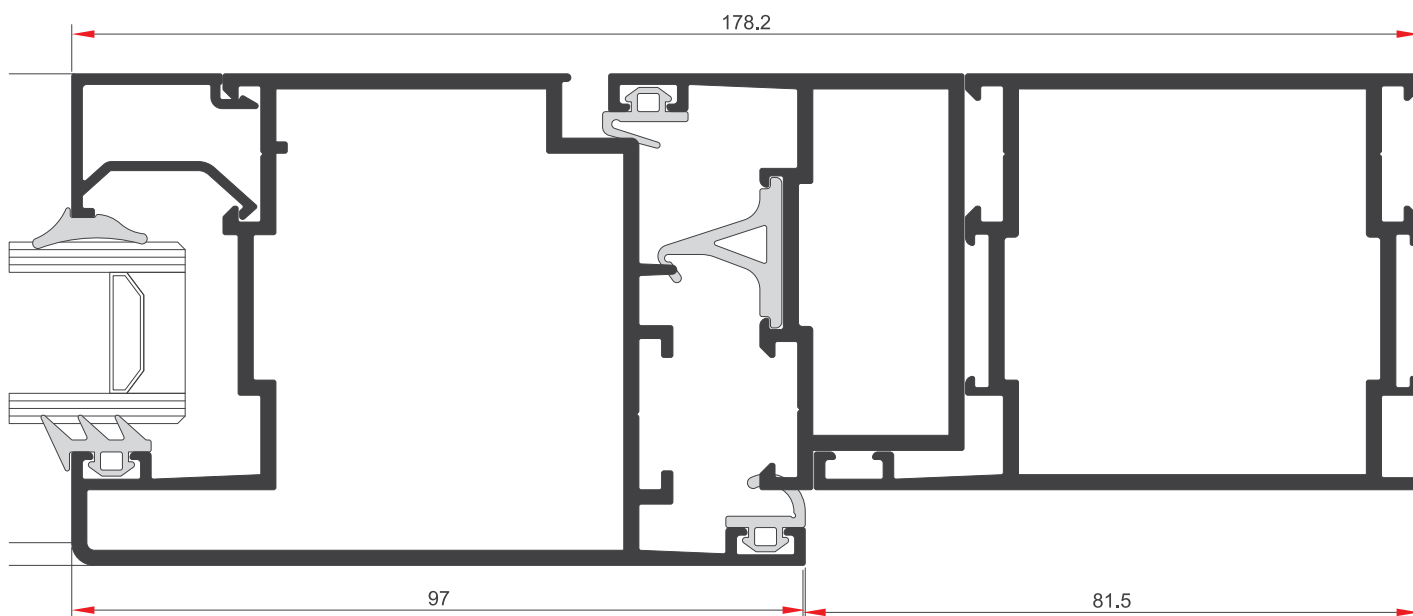

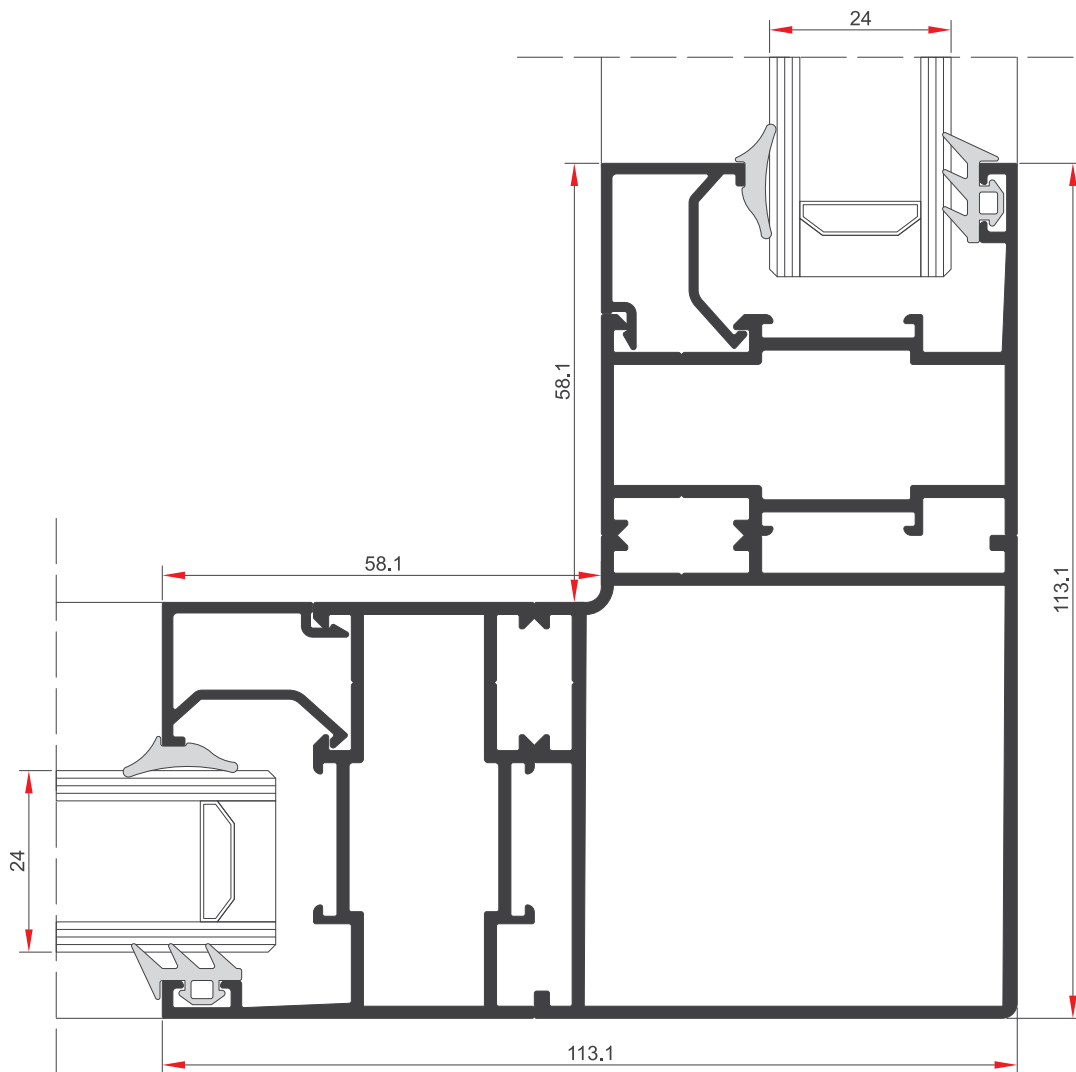



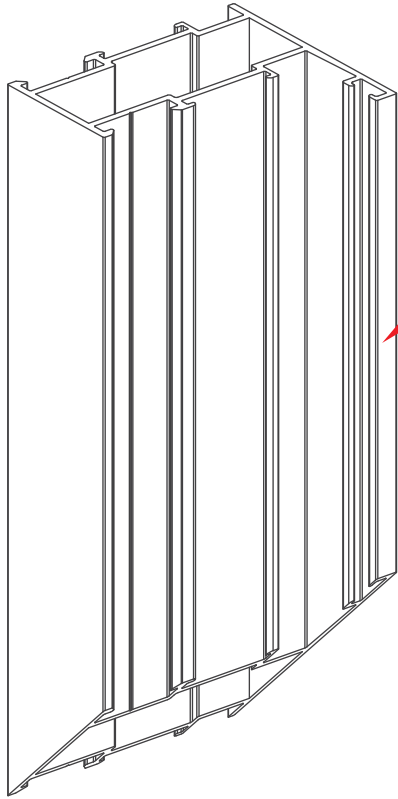

SW55 KS XX

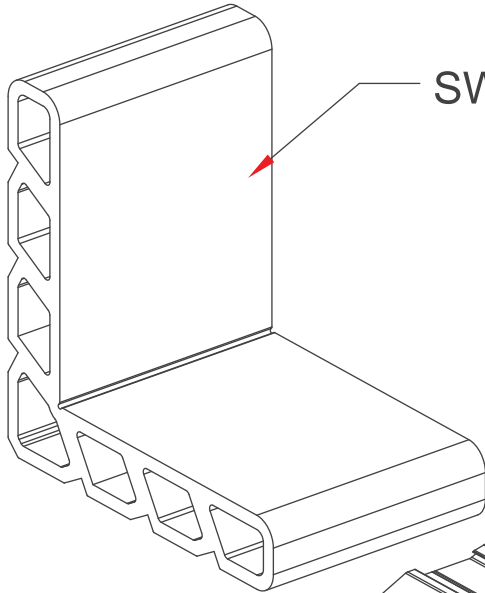

SWT55 KT XX

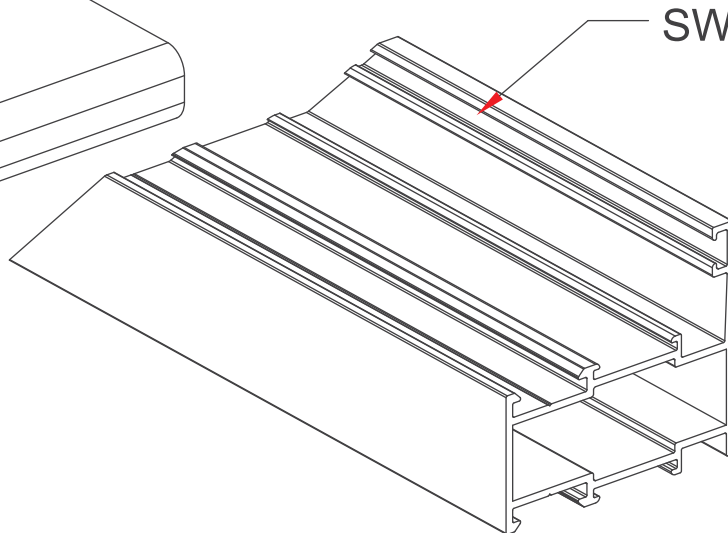

SW55 KS XX

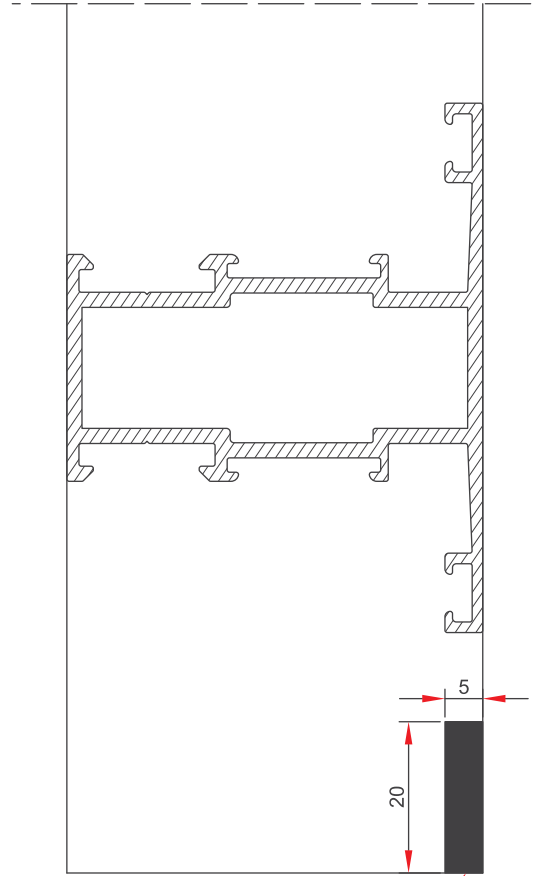
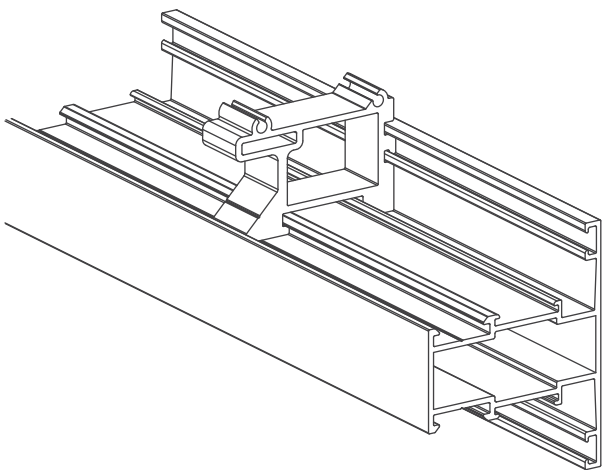
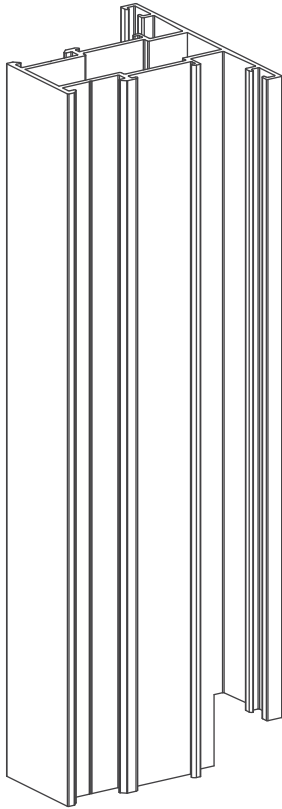

KERTME

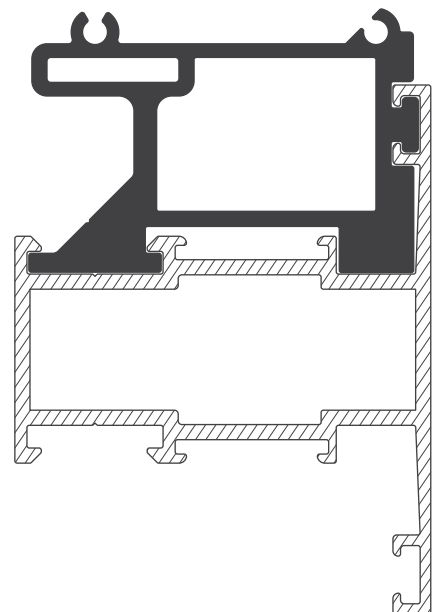

# ALUSYSTEMS

Aluminyum Kapı Pencere ve Giydirme Cephe Sistemleri  
Aluminium Window Doors and Facade Systems



# MİMARİ KATALOG

## ARCHITECTURAL CATALOGUE

Aluminyum Kapı Pencere ve Giydirme Cephe Sistemleri  
Aluminium Window Doors and Facade Systems



ALUSYSTEMS  
Profil Detayları

ALUSYSTEMS  
Profile Details

# SW55

**AKSESUARLAR**  
ACCESSORIES

# ALUSYSTEMS



Aluminyum Kapı Pencere ve Giydirme Cephe Sistemleri  
Aluminium Window Doors and Facade Systems





FITIL001		<p>DİŞ CAM FİTİLİ GLAZING GASKET (OUTSIDE)</p> <p>Malzeme/ Material : EPDM Ağırlık/ Weight : 61 gr/m Paket/ Package: 245 m / 15 kg</p>	
FITIL002		<p>DİŞ BİNİ FİTİLİ SEALING GASKET (OUTSIDE)</p> <p>Malzeme/ Material : EPDM Ağırlık/ Weight : 40 gr/m Paket/ Package: 375 m / 15 kg</p>	
FITIL003		<p>İÇ BİNİ FİTİLİ SEALING GASKET (INSIDE)</p> <p>Malzeme/ Material : EPDM Ağırlık/ Weight : 50 gr/m Paket/ Package: 300 m / 15 kg</p>	
FITIL004		<p>KAMA FİTİLİ GLAZING GASKET (INSIDE)</p> <p>Malzeme/ Material : EPDM Ağırlık/ Weight : 46 gr/m Paket/ Package: 326 m / 15 kg</p>	
FITIL005		<p>KAMA FİTİLİ GLAZING GASKET (INSIDE)</p> <p>Malzeme/ Material : EPDM Ağırlık/ Weight : 56 gr/m Paket/ Package: 268 m / 15 kg</p>	

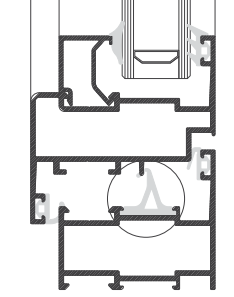

FITIL006		<p>TOZLUK FİTİLİ CENTRAL GASKET</p> <p>Malzeme/ Material : EPDM Ağırlık/ Weight : 117 gr/m Paket/ Package: 128 m / 15 kg</p>	
FITIL007		<p>EŞİK FİTİLİ THRESHOLD GASKET</p> <p>Malzeme/ Material : EPDM Ağırlık/ Weight : 66 gr/m Paket/ Package: 227 m / 15 kg</p>	